



© Cover:  
Ingrid Klimke (left) by Ingo Wächter Images,  
Jos Lansink (middle) by Arndt Bronkhorst,  
Charlotte Dujardin (right) by Sebastian Oakley

**HS<sup>®</sup> SPRENGER**

**EQUESTRIAN PRODUCTS**

**2017/2018**



Offizieller Kompetenzpartner des  
DOKR-Bundesleistungszentrums

Ingrid Klimke is an all-round equestrian talent. She overcomes all obstacles – even with dressage stallion Franziskus – and puts her trust into Sprenger products she uses for all disciplines. Just like numerous professional and talented riders at the German Olympic Committee for Equestrian.

© Picture: Ingrid Klimke on Franziskus by LL-FOTO



# QUALITY, THAT PERFORMS.

We are the partner for horse and rider.





In 1872, Hermann Sprenger founded a factory for riding accessories. In the course of the years, his successors added the manufacture of boat fittings and dog furnishings. Herm. Sprenger is renowned for its outstanding quality and technologically advanced designs. For over 135 years the combination of hard work, commitment to excellence and innovative technology has enabled Herm. Sprenger to attain its current position as the world leader in bit design and production. Decades of experience in manufacturing,

an extensive market knowledge and collaboration with professionals from the fields of sports, medicine, design and research constitute the basis for the development of international standards. Our demand for quality begins with the selection of raw materials and the sensitive composition of our patented alloys.

The SPRENGER seal of quality guarantees safety and precision workmanship.





# INTERNATIONAL TOP RIDERS TRUST IN SPRENGER QUALITY.



© Pictures:  
Ingrid Klimke (left) by Ingo Wächter Images,  
Jos Lansink (middle) by Arndt Bronkhorst,  
Charlotte Dujardin (right) by Sebastian Oakley



**Ingrid Klimke**

"For many years I have been using Sprenger bits, spurs and stirrups as my horses feel very comfortable with them and only the best is just good enough for my four-legged sport partners."



**Charlotte Dujardin**

"With decades of experience and commitment to design and research, I choose Sprenger with confidence for my horses so they can perform at their very best."



**Klaus Balkenhol**

"Sprenger and I have worked closely together on many innovative ideas and over the years we have kept developing new products. I am delighted with Sprenger's commitment to horse and rider welfare and the incomparable quality of their products."



**Jean Bemelmans**

"The company philosophy of Sprenger has convinced me. The horse's mouth is extremely sensitive and Sprenger are always up to date with their intensive research caring for the needs of horse and rider. Their motto "Leading with feeling" speaks for itself."



**Jos Lansink**

"For many years I have been riding with Sprenger bits and stirrups. Reliability and safety are first for me and I can truly rely on Sprenger."



**Alois Pollmann-Schweckhorst**

"For me Sprenger products are invincible. My favourites are the Dynamic RS and the Bow Balance stirrups which are used on almost every horse in our stables."



**Jessica von Bredow-Werndl  
and Benjamin Werndl**

"To gain horses as partners is – apart from a sensitive and varied education – only possible with a perfectly fitted bit for each individual horse. For us there is only one partner who shares this passion for the perfection of the communication with the horse just like we do: Sprenger."



**Carl Hester**

"The horse's mouth is to be respected and Sprenger bits use only the finest metals and craftsmanship – giving me total reassurance. Your horse only has one mouth – so make sure you use the best bits available: Sprenger."





**Laura Tomlinson**

"We use Sprenger bits for all our horses. Sprenger manufacture and design top quality, research proven bits. They are committed to providing a sensitive connection between horse and rider – a happy horse is a horse ridden in Sprenger. I wouldn't use any other brand of bit."

*Laura Tomlinson*



**Ruth Edge**

"For me the Sprenger bits give me the ultimate feel and connection with my horse's mouth and the quality is second to none."

*Ruth Edge*



**Hubertus Schmidt**

"Sprenger products are superior due to the combination of functionality and design. Whether it is bits, stirrups or spurs – for me there is no alternative."

*Hubertus Schmidt*



**Jan Ebeling**

"The connection I establish in training is the most important element in my system. Herm. Sprenger's brand of bits and spurs are my trusted choice with all my horses."

*Jan Ebeling*



**Guenter Seidel**

"Having worked with Klaus Balkenhol for many years I am very pleased to also use Sprenger products. Sprenger seems to always have a solution for all situations and is far above the rest in quality, design and performance. I am honored to be associated with Sprenger products."

*Guenter Seidel*



**Marco Kutscher**

"To perform at the highest level regularly, everything must be right. Sprenger develops products for all types and characters of horses which makes my life easier for competitions. When you're jumping a course you have to react fast and need reliable equipment."

*Marco Kutscher*



**Helen Langehanenberg**

"The huge Sprenger range helps me find the right bit for every horse. The materials Aurigan and SENSOGAN are unique and effective since they are specially developed to be used in a horse's mouth. This is why Sprenger bits are indispensable for me and my horses. You shouldn't compromise when it comes to the very sensitive mouth of your horse – quality is what counts."

*Helen Langehanenberg*



**Roger-Yves Bost**

"When it comes to biting there is only one choice for the comfort and well-being of my horses: Sprenger!"

*Roger-Yves Bost*



**Markus und Johannes Ehning**

"In horse riding safety is a must! This is why we only use Sprenger's System-4 and Bow Balance stirrups that fulfil our high requirements on quality and functionality."

*Markus und Johannes Ehning*



**Fia Lindh**

"I have always been very happy to use Sprenger bits and after I have started using SENSOGAN, my horses seem better to accept the bit and feel more relaxed in the mouth and thereby less tense in the rest of the body. The result: a happier horse and rider."

*Fia Lindh*



**Bettina Hoy**

"Sprenger puts priority into safety – and so do I. I cannot imagine Eventing without the Bow Balance stirrups and I wouldn't know how to ride my horses without Sprenger bits."

*Bettina Hoy*



**Lisa Wilcox**

"Sprenger have proven to be the best through their high quality and innovation, producing new products that are improving the way the riders communicate with their horse. It has been a great experience for me to be able to share my ideas and concepts with Sprenger. Together with Sprenger we developed the WH ULTRA bit which I am thrilled with, my horses love it! Only the best for me and my horses!"

*Lisa Wilcox*

# Your SPRENGER- Sales-Team:

## Sales Manager

### **Brigitte Lüdemann**

Tel.: +49 (0) 23 71-95 59-22  
brigitte.luedemann@sprenger.de

## Sales Germany – Office

### **Sina Grundmann**

Tel.: +49 (0) 23 71-95 59-55  
grundmann@sprenger.de  
PLZ 1, 2, 30-33, 38, 39, 49, 7, 8, 90-97

### **Andrea Wieczorek**

Tel.: +49 (0) 23 71-95 59-54  
wieczorek@sprenger.de  
PLZ 0, 34-37, 40-48, 5, 6, 98, 99

## Sales Germany – Representative

### **Heiko Schmidt-Sentek**

PLZ 1, 2, 30-33, 38, 39, 49

### **Josef Wulf**

PLZ 0, 34-37, 40-48, 50-54, 56-59, 98, 99

### **Alexander Strübel**

PLZ 55, 6, 7, 8, 90-97

## Sales Export

### **Detlef Rombach**

Tel.: +49 (0) 23 71-95 59-71  
detlef.rombach@sprenger.de  
BeNeLux, F, P, Middle East,  
East Europe, USA

### **Marc Meiritz**

Tel.: +49 (0) 23 71-95 59-74  
meiritz@sprenger.de  
A, CH, E, GB, I, Canada, South America,  
South Africa, Far East

### **Deike Bräutigam**

Tel.: +49 (0) 23 71-95 59-58  
braeutigam@sprenger.de  
DK, N, S, SF, Russia,  
Baltic States, Australia



# ALWAYS UP TO DATE

[www.sprenger.de](http://www.sprenger.de)





Snaffles and Weymouth bits..... 6-67

1.0

1.0 SNAFFLES AND WEYMOUTH BITS

Stirrups..... 68-75

2.0

2.0 STIRRUPS

Spurs..... 76-85

3.0

3.0 SPURS

Grooming Items..... 86-98

4.0

4.0 GROOMING ITEMS

Sellings aids..... 99-103

5.0

5.0 SELLING AIDS

Harness Fittings and Index..... 104-128

6.0

6.0 HARNESS FITTINGS AND INDEX

A close-up, high-angle photograph of a silver metal horse bit. The bit is positioned diagonally across the frame, with its mouthpiece and rings clearly visible. The background is dark and out of focus, emphasizing the metallic texture and curves of the bit.

# SNAFFLES AND WEYMOUTH BITS

**Harmony on horse-back starts with a well-fitting bit.**

The bit operates as a method of communication between rider and horse. It directs the riders rein aids straight to the horse's mouth. As the mouth is one of the most sensitive parts of the horse's body it is important to treat it very carefully. A bit should be adapted to the individual shape of a horse's mouth and should neither be uncomfortable nor awkward for the horse in any way. Choosing the right bit allows effective communication through the reins between rider and horse – a basic requirement for correct riding.

SPRENGER gains its outstanding scientific knowledge of the horse's mouth anatomy through intensive research in collaboration with

the University of Veterinary Medicine Hannover. The SPRENGER Development-Center continuously works on innovative products with optimised design and effectiveness, based on current research data. International Top-Riders use SPRENGER products and appreciate and confirm their outstanding quality and effectiveness.

The use of a well-fitted, high quality bit means horsemanship and animal welfare are put into practice!

We trust that you will enjoy your next ride with SPRENGER products.

Your SPRENGER-Team



## 1.0

<b>Snaffles and Weymouth bits</b> .....	<b>6-67</b>
1.1 SENSOGAN.....	8-9
1.2 AURIGAN.....	10
1.3 KK ULTRA bits.....	11-15
1.4 Dynamic RS bits.....	16-23
1.5 WH ULTRA bits.....	24-25
1.6 novocontact bits.....	26-29
1.7 Mullen Mouth bits.....	30-31
1.8 TURNADO bits.....	32-33
1.9 Loose Ring snaffles.....	34-35
1.10 Eggbutt bits and Hardcarbon bits.....	36-37
1.11 D-Ring snaffles.....	38-39
1.12 Pelhams.....	40-41
1.13 Jumping bits.....	42-43
1.14 DUO bits.....	44
1.15 Rubber bits.....	45
1.16 Full Cheek snaffles.....	46-47
1.17 MAX-Control bits.....	48-49
1.18 Hackamores.....	50
1.19 Special bits / Spoon Mouth bits.....	51
1.20 Weymouth bits and accessories.....	52-60
1.21 Bradoons.....	61-63
1.22 Bits, Copper Plus.....	64
1.23 Driving bits.....	65-67

#### QUALITIES AVAILABLE

<b>00</b> miscellaneous
<b>02</b> steel chrome plated
<b>40</b> German Silver highly polished
<b>55</b> HS-stainless steel
<b>56</b> stainless steel
<b>71</b> rubber black
<b>78</b> SENSOGAN with stainless steel rings / cheeks
<b>79</b> SENSOGAN with Aurigan rings / cheeks
<b>88</b> Aurigan with stainless steel rings / cheeks
<b>89</b> Aurigan with Aurigan rings / cheeks
<b>94</b> Copper Plus

#### PLEASE NOTE

Quality keys and dimensions can also be found on the last page of this catalogue.



# SENSOGAN®

## The sensitive connection to the horse.

An optimal communication between horse and rider is the basis for performance and success. The bit mouthpiece is the essential tool in this communication as it conveys the rein aids the rider gives to the horse's mouth. Over the past decades SPRENGER has dedicated itself to the ongoing development of its bits. The horses' health and their well-being is the main research and development focus for our high-quality German-manufactured products.

---

### A milestone for horse and rider

---

**SENSOGAN** – the new bit material developed by SPRENGER – is the result of additional development and consequently the improvement of our original material, Aurigan. We have built on the success and positive features of Aurigan, specifically the taste and salivation aspects to give an even more delicate and sophisticated connection to the horse. It is the distinctive composition of copper, manganese and

zinc that makes **SENSOGAN** so special. With a reduced copper content the oxidation process is still maintained, however, the extraordinary combination with manganese is what makes the difference. This combination results in a smoother and more regulated process of oxidation. Tests show a very positive influence on the horse's satisfaction, motivation and willingness to perform.

The copper discharge quantity into the horse's saliva is reduced considerably, which helps to keep the noble white-gold colour for a longer time. The new ingredient manganese on the other hand is an important micronutrient. As a crucial component and activator of enzymes, manganese is highly relevant for building up connective tissue as well as for the muscle and energy metabolism. It can therefore be helpful in preventing muscle tension and in supporting stress reduction. Beyond that, manganese is needed for the reduction of histamine and can prevent allergic skin reactions. Also, the feed industry discovered manganese to be a promising food additive that is gaining in importance in modern feeding of sport horses.





**Optimal effects – unmatched look**

**SENSOGAN** has improved properties but also a new appearance. The white-gold colour gives the bit a discreet and elegant look and due to the improved material mix, **SENSOGAN** does not tarnish easily as the chewing activity of the horse is optimally supported. It is easy to care for and maintains its elegant appearance over a long time period. All **SENSOGAN** bits are marked with a black ring at the cheeks. On the following pages you will find **SENSOGAN** bits (quality codes 78 and 79) for all your individual needs and preferences.

- > toxicologically tested
- > high compatibility and exceptionally well tolerated
- > easy to clean
- > consistent flow of saliva

International Patent pending  
PCT/EP2013/076886

A wide range of our bit designs is now available in **SENSOGAN**. It is also possible to purchase many of the various mouthpieces with bit rings and cheeks made from stainless steel and Aurigan to ensure your bit matches your individual bridle design.

**Intensive research and development**

When it comes to developing and redesigning new models and products, we work closely together with a team of experts. It often takes months and years of research and testing to find positive results. As far as the development of **SENSOGAN** is concerned, the special challenge was to maintain the positive features of Aurigan and to intensify them. In collaboration with the Veterinary University of Medicine Hannover and the German Riding School in Warendorf this breakthrough was achieved and **SENSOGAN** was born. The scientifically proven tests showed without doubt the extremely positive effects of the new material.



**Helen Langehanenberg**

“The huge Sprenger range helps me find the right bit for every horse. The materials Aurigan and SENSOGAN are unique and effective since they are specially developed to be used in a horse’s mouth. This is why Sprenger bits are indispensable for me and my horses. You shouldn’t compromise when it comes to the very sensitive mouth of your horse – quality is what counts.”



# AURIGAN®



## First there was AURIGAN

**AURIGAN** is the first biting material developed specifically for the use in the horse's mouth. It has very strong oxidation properties due to the special composition of copper, silicon and zinc and, therefore, actively encourages the production of saliva. The use of AURIGAN in the horse's mouth has been proven by researches of the Veterinary University of Medicine Hannover.

**AURIGAN** bits are made from a solid cast. Tarnishing arises from the natural oxidation process in the open air.

On the following pages you will find **AURIGAN** bits (quality codes 88 and 89) to suit all your individual needs and preferences.







## KK ULTRA – developed according to scientific research.

KK ULTRA bits take advantage of the exceptional sensitivity of the tongue. The tongue is so extremely sensitive that it multiplies perceptions in this area dramatically.

The Veterinary University of Medicine Hannover and SPRENGER measured a variety of horses' heads to prove the space that is available in a horse's mouth. The result is that the mouth cavity is smaller than originally assumed and therefore the space available for a bit is quite limited. The most popular bit thicknesses are 14 to 18 mm nowadays.

In collaboration with SPRENGER the Veterinary University of Medicine Hannover found out that a horse's mouth is smaller and narrower than generally assumed. Based on this scientific information, SPRENGER developed the KK ULTRA bits with a short lozenge and a link that is turned in front by 45 degrees. That way the mouthpiece creates the best possible effect in the horse's mouth.

KK ULTRA bits create an incomparable sensitive contact between horse and rider. The anatomically formed mouthpiece lies perfectly in the horse's mouth enabling the rider to give subtle aids. A huge improvement is usually seen immediately when the horse's bit is switched to any kind of KK ULTRA bit.

**KK ULTRA bits are characterised by:**

- **the unique angle of 45 degrees** is the only way to get a true contact to the tongue. The round lozenge rolls down smoothly over the tongue and stimulates it in a gentle but effective way. Clearly defined aids can be given through the reins without squeezing the tongue.
- **no pressure on the palate** – the ergonomically designed mouthpiece is shaped like the horse's tongue and therefore taking up less room in the mouth without interfering with the palate.
- **gentle to mouth and tongue** – this mouthpiece encourages a high level of responsiveness by an optimum contact resulting in relaxation and submissiveness.

European patent no. EP 1 140 693 B1  
US patent no. US 6,425,229 B2

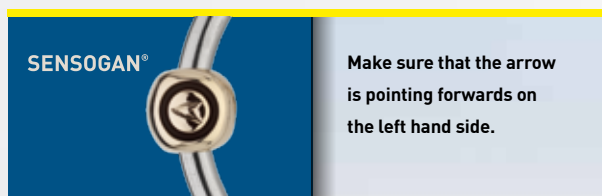

SENSOGAN®

Make sure that the arrow is pointing forwards on the left hand side.

### KK ULTRA

KK ULTRA – Compared to conventional bits, the double jointed KK ULTRAS have a middle link – also known as the bean – that is shortened and angled forward by 45°. Only with this angle the middle link lies gently on the tongue resulting in even and constant contact to allow clear instructions through the reins.

The innovative KK ULTRA bits take advantage of the exceptional sensitivity of the horse’s tongue which multiplies the perceptions from signals given by the bit. When the reins are pulled the middle part of the KK ULTRA fully rests on the tongue without squeezing and the connection rings roll on the tongue. The tongue’s sense of touch is utilised and clear instructions can be given. The KK ULTRA bits provide an incomparable precise contact between rider and horse. A huge improvement can normally be seen immediately when switching to a KK ULTRA bit.

The anatomically adapted mouthpiece is very comfortable for the horse as the rider can give softer instructions and the horse’s suppleness is supported harmoniously.

#### Laura Tomlinson

“We use Sprenger bits for all our horses. Sprenger manufacture and design top quality, research proven bits. They are committed to providing a sensitive connection between horse and rider – a happy horse is a horse ridden in Sprenger. I wouldn’t use any other brand of bit.”



### KK ULTRA

SENSOGAN®  
AURIGAN

article no.	size (mm)	qualities available		size (inch)	thickness (mm)	ring-Ø (mm)	box quantity
40605	105	78		4.1/8	14	70	5
	115	78		4.1/2	14	70	5 *
	125	78	88	5.	14	70	5 *
	135	78	88	5.1/4	14	70	5 *
	145	78	88	5.3/4	14	70	5 *
155	78			6.1/8	14	70	5 *
40604	125	78	79 88	5.	16	70	5 *
	135	78	79 88	5.1/4	16	70	5 *
	145	78	79 88	5.3/4	16	70	5 *
	155	78		6.1/8	16	70	5 *
	165	78	88	6.1/2	16	70	5 *
40606	110		88	4.1/4	18	55	5 *
	120	78	79 88	4.3/4	18	70	5 *
	130	78	79 88	5.1/8	18	70	5 *
	140	78	79 88	5.1/2	18	70	5 *
	150	78	88	6.	18	70	5 *
	160	78	88	6.1/4	18	70	5 *
	175		88	7.	18	70	2
40600	120	78	88	4.3/4	21	70	5 *
	130	78	88	5.1/8	21	70	5 *
	140	78	88	5.1/2	21	70	5 *
	150	78	88	6.	21	70	5 *

### KK ULTRA bradoon

SENSOGAN®  
AURIGAN



article no.	size (mm)	qualities available		size (inch)	thickness (mm)	ring-Ø (mm)	box quantity
40201	115	78		4.1/2	12	55	2 *
	125	78		5.	12	55	2 *
	135	78		5.1/4	12	55	2 *
	145	78		5.3/4	12	55	2 *
40200	105	78	79 88	4.1/8	14	55	2
	115	78	79 88	4.1/2	14	55	2 *
	125	78	79 88	5.	14	55	2 *
	135	78	79 88	5.1/4	14	55	2 *
	145	78	79 88	5.3/4	14	55	2 *
	155	78	79 88	6.1/8	14	55	2 *
40224	115	78		4.1/2	16	55	2 *
	125	78		5.	16	55	2 *
	135	78		5.1/4	16	55	2 *
	145	78		5.3/4	16	55	2 *



### KK ULTRA Eggbutt

SENSOGAN®  
AURIGAN™

Highly recommended for horses that require an improvement of the contact with the bit. Eggbutts are suitable for horses with sensitive mouth corners as they prevent them from being pinched. As the rings are fixed to the mouthpiece they keep the bit steady in the mouth. They also prevent the bit from being pulled through the mouth, enabling the KK ULTRA mouthpiece to direct gentle pressure onto the central point of the tongue.

article no.	size (mm)	qualities available			size (inch)	thickness (mm)	ring-Ø (mm)	box quantity
40366	125	78	89		5.	18	70	2 *
	135	78	89		5.1/4	18	70	2 *
	145	78			5.3/4	18	70	2 *



### KK ULTRA Eggbutt bradoon

SENSOGAN®  
AURIGAN™

article no.	size (mm)	qualities available			size (inch)	thickness (mm)	ring-Ø (mm)	box quantity
40367	115	78	89		4.1/2	14	55	2 *
	125	78	89		5.	14	55	2 *
	135	78			5.1/4	14	55	2 *
	145	78			5.3/4	14	55	2 *
	155	78	89		6.1/8	14	55	2



### KK ULTRA D-Ring

SENSOGAN®

The D-Rings prevent the bit from being pulled through the horse's mouth so it lies more steadily on the tongue giving a more comfortable feeling. Gentle pressure is pivoted directly onto the tongue ensuring light and precise rein aids. The fixed rings enable the rider a good contact with the bit and support sideways acting rein aids.

article no.	size (mm)	qualities available			size (inch)	thickness (mm)	ring-Ø (mm)	box quantity
40416	125	78			5.	15	80	2 *
	135	78			5.1/4	15	80	2 *
	145	78			5.3/4	15	80	2 *
	155	78			6.1/8	15	80	2 *



### KK ULTRA 2-TYPE



SENSOGAN®

#### Eggbutt bit with loose rings

This bit combines the advantages of a loose ring snaffle and the lateral contact of an eggbutt. Due to the eggbutt shape it is gentle on the corners of the mouth while the anatomically formed mouthpiece lies perfectly in the mouth ensuring extremely gentle pressure and precise rein aids. Additionally, the KK ULTRA 2-TYPE maintains the lightness of a loose ring snaffle.

article no.	size (mm)	qualities available			size (inch)	thickness (mm)	ring-Ø (mm)	box quantity
40613	115	78			4.1/2	16	70	2
	125	78			5.	16	70	2 *
	135	78			5.1/4	16	70	2 *
	145	78			5.3/4	16	70	2 *



**KK ULTRA B-Ring**  
 with SENSOGAN cheeks (quality 79)

 SENSOGAN®  
 AURIGAN™

**Long-term correction of tongue vices**

The rein is attached to the lower ring, the cheekpiece to the smaller upper one. The B-Ring bit has a lever action on the poll that is good for horses that are prone to being above the bit. The special way of attaching it means that it prevents the horse from putting the tongue over the bit. When the horse lifts the head the pressure remains on the tongue and does not act towards the back teeth.

article no.	size (mm)	qualities available			size (inch)	thickness (mm)	box quantity
40413	115	79		89	4.1/2	16	2 *
	125	79		89	5.	16	2 *
	135	79			5.1/4	16	2 *
	145	79		89	5.3/4	16	2 *

**KK ULTRA Baucher**  
 with SENSOGAN cheeks (quality 79)

 SENSOGAN®  
 AURIGAN™

This is a perfect bit when changing from a snaffle to a Weymouth in Dressage as it enables precise action on the mouth and poll of the horse. Gentle pressure is directed on the poll by attaching the rein onto the lower ring and the cheekpiece onto the upper smaller one. Combined with simultaneous pressure on the tongue, the horse is gently directed to the correct low/downward poll positioning. Together with the excellent features of the KK ULTRA mouthpiece the rider is able to achieve great results with an improved, consistent contact.

article no.	size (mm)	qualities available			size (inch)	thickness (mm)	ring-Ø (mm)	box quantity
41081	115	78			4.1/2	16	45	2
	125	78	79	88	5.	16	45	2 *
	135	78	79		5.1/4	16	45	2 *
	145	78	79	88	5.3/4	16	45	2 *

**KK ULTRA Gag**

SENSOGAN®

With the use of 2 reins in combination with a special cheekpiece for gag bits this bit enables an effective and precise control on the horse's mouth and poll. Particularly suitable for horses that tend to push forward. The pressure on the poll that the rider achieves gives maximum control. Gag bits are very popular in the fields of Jumping and Polo.

article no.	size (mm)	qualities available			size (inch)	thickness (mm)	ring-Ø (mm)	box quantity
40431	125	78			5.	16	80	2 *
	135	78			5.1/4	16	80	2 *
	145	78			5.3/4	16	80	2 *

**Gag cheeks (by pair)**, Leather with nylon rope round webbed

42115	000	00			colour: black / length: 45 cm		1 *
	001	00			colour: dark brown / length: 45 cm		1 *

**KK ULTRA Kimblewick**

 SENSOGAN®  
 AURIGAN™

Works in a similar way to a Pelham. It can be ridden with two reins and the use of a curb chain puts additional pressure on the horse's poll. However, the lever action is considerably low due to the shorter D-Ring shaped cheeks, resulting in less pressure.

article no.	size (mm)	qualities available			size (inch)	thickness (mm)	box quantity
42311	125	78		88	5.	16	2 *
	135	78			5.1/4	16	2 *
	145	78		88	5.3/4	16	2 *



### KK ULTRA 3-Ring

SENSOGAN®

This 3-Ring bit enables 4 different ways of attaching the reins to the bit (see 40618). It is therefore very versatile and extremely popular among Jumpers as it can achieve more control when needed. Depending on the way the reins are being attached to the rings varying degrees of lever action intensify the rider's aids. The most effective results are achieved by the use of a second rein.

article no.	size (mm)	qualities available		size (inch)	thickness (mm)	ring-Ø (mm)	box quantity
40607	120	78		4.3/4	18	70	2 *
	130	78		5.1/8	18	70	2 *
	140	78		5.1/2	18	70	2 *



### KK ULTRA Universal

SENSOGAN®  
AURIGAN®

This bit is also extremely versatile due to the different rein options. It is a good choice for sensitive horses as it is a little bit softer than model 40607, leading to a higher level of acceptance. The lever action has a slight delay due to the lateral offset position of the upper ring. Riders can additionally add a curb strap to get more direct action. The pressure on the poll is limited that way.

article no.	size (mm)	qualities available		size (inch)	thickness (mm)	ring-Ø (mm)	box quantity
40618	115	78	88	4.1/2	16	70	2 *
	125	78	88	5.	16	70	2 *
	135	78	88	5.1/4	16	70	2 *
	145	78	88	5.3/4	16	70	2 *
40608	120	78		4.3/4	18	70	2 *
	130	78		5.1/8	18	70	2 *
	140	78		5.1/2	18	70	2 *
42111	000	00		black / length: 59 cm			5

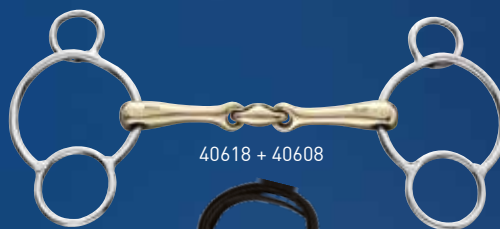

40618 + 40608

42111



### KK ULTRA Full Cheek

SENSOGAN®  
AURIGAN®

This bit lies quietly in the horse's mouth as the cheeks prevent the bit from being pulled through and therefore avoids inconvenient pressure on the back teeth. The mouthpiece remains in the correct central position of the tongue ensuring the rein aids work perfectly in the horse's mouth. The cheeks are most helpful with turning aids especially with young horses. The gentle pressure against the face on the outside of the turn supports the rider's aid making turns much easier for the horse to understand and for the rider to carry out. The upper part of the cheeks are curved outwards away from the horse to avoid uncomfortable pressure on the jaws.

article no.	size (mm)	qualities available		size (inch)	thickness (mm)	ring-Ø (mm)	box quantity
41606	120	78	88	4.3/4	18	50	2 *
	130	78		5.1/8	18	50	2 *
	140		88	5.1/2	18	50	2 *



#### Marco Kutscher

"To perform at the highest level regularly, everything must be right. Sprenger develops products for all types and characters of horses which makes my life easier for competitions. When you're jumping a course you have to react fast and need reliable equipment."



SPRENGER  
**Dynamic RS**



# Ergonomically formed, gentle to the horse's mouth.

Dynamic RS bits stimulate the horse to accept the bit more easily.

The ergonomically formed mouthpiece allows a rapid and balanced effect on the tongue.

- **no pressure to the palate**  
Dynamic RS mouthpieces give even pressure on the entire tongue area.
- **gentle to mouth and tongue**  
Supports the contact to the corners of the mouth in an extremely effective way, keeping the horse on the bit.
- **the link of the mouthpiece is turned to the front by 45°**  
This unique angle is the only way to get a true contact with the tongue. When a contact is taken the mouthpiece rolls smoothly over the horse's tongue and stimulates it in a gentle but effective way. Clearly defined aids can therefore be given through the reins without squeezing the tongue.

#### Totally dynamic.

The ergonomically formed mouthpiece lies perfectly in the horse's mouth resulting in soft and even pressure on the entire tongue area, encouraging the horse to chew. In addition this bit supports the contact to the corners of the mouth in a very effective way, keeping the horse on the bit. The gentle joint in the middle which is angled forward – the characteristic feature of the KK ULTRA – and the fine eggbutt design makes it a very friendly bit.

Due to the curved joints the bit remains in the correct and central position on the tongue. The fine lozenge can direct gentle pressure pivotally onto the tongue. The bit encourages the confidence of the horse in the rider's hand and increases safety.

European patent no. EP 1 140 693 B1  
US patent no. US 6,425,229 B2

SENSOGAN®



Make sure that the arrow is pointing forwards on the left hand side.

**DYNAMIC RS bits**

DYNAMIC RS bits are suitable for horses with contact problems. Due to the ergonomically shaped mouthpiece they lie perfectly in the horse's mouth resulting in soft and even pressure on the entire tongue area, encouraging the horse to chew. The gentle joint in the middle which is angled forward by 45° – the characteristic feature of the patented KK ULTRA and Turnado bits – enables clearly defined rein aids.

The DYNAMIC RS bit series gives soft but very effective impulses for a better contact between horse and rider.



Alois Pollmann-Schweckhorst



"I very rarely had a bit that worked so well on all horses. The horses that are softer in the mouth are willing to step into the hand and the horses who are a little tighter in the poll are happier to accept the half halt giving hand. Every horse I have ridden with a **Dynamic RS** improved considerably."  
Alois Pollmann-Schweckhorst

**Dynamic RS  
with flat rings, double jointed**

 SENSOGAN®  

article no.	size (mm)	qualities available		size (inch)	thickness (mm)	ring-Ø (mm)	box quantity
<b>40414</b>	<b>110</b>	<b>78</b>	<b>88</b>	4.1/4	14	65	2
	<b>115</b>	<b>78</b>	<b>88</b>	4.1/2	14	65	2 *
	<b>125</b>	<b>78</b>	<b>88</b>	5.	14	65	2 *
	<b>135</b>	<b>78</b>	<b>88</b>	5.1/4	14	65	2 *
<b>40406</b>	<b>145</b>	<b>78</b>	<b>88</b>	5.3/4	14	65	2 *
	<b>125</b>	<b>78</b>	<b>88</b>	5.	16	65	2 *
	<b>135</b>	<b>78</b>	<b>88</b>	5.1/4	16	65	2 *
	<b>145</b>	<b>78</b>	<b>88</b>	5.3/4	16	65	2 *
<b>155</b>	<b>78</b>	<b>88</b>	6.1/8	16	65	2 *	

**Dynamic RS  
with small flat rings, double jointed**

 SENSOGAN®  

article no.	size (mm)	qualities available		size (inch)	thickness (mm)	ring-Ø (mm)	box quantity
<b>40244</b>	<b>110</b>	<b>78</b>	<b>88</b>	4.1/4	14	55	2 *
	<b>115</b>	<b>78</b>	<b>88</b>	4.1/2	14	55	2 *
	<b>125</b>	<b>78</b>	<b>88</b>	5.	14	55	2 *
	<b>135</b>	<b>78</b>	<b>88</b>	5.1/4	14	55	2 *
	<b>145</b>	<b>78</b>	<b>88</b>	5.3/4	14	55	2 *

**Dynamic RS Eggbutt bradoon  
with Eggbutt rings, double jointed**

SENSOGAN®

article no.	size (mm)	qualities available		size (inch)	thickness (mm)	ring-Ø (mm)	box quantity
<b>40248</b>	<b>115</b>	<b>78</b>		4.1/2	14	55	2 *
	<b>125</b>	<b>78</b>		5.	14	55	2 *
	<b>135</b>	<b>78</b>		5.1/4	14	55	2 *
	<b>145</b>	<b>78</b>		5.3/4	14	55	2 *

**Dynamic RS WH ULTRA  
with flat rings, double jointed**

 SENSOGAN®  

Combines the advantages of both the Dynamic RS and WH ULTRA in one unique bit design. The anatomically formed mouthpiece of the Dynamic RS bit is perfectly adapted to the horse's mouth resulting in ultimate comfort for the horse. Together with the relaxing effect of the WH ULTRA lozenge horses get softer and more responsive to the rein aids. Make use of this most advanced communication with your horse and let yourself experience utmost satisfaction.

article no.	size (mm)	qualities available		size (inch)	thickness (mm)	ring-Ø (mm)	box quantity
<b>40428</b>	<b>120</b>	<b>78</b>	<b>88</b>	4.3/4	16	65	2 *
	<b>130</b>	<b>78</b>	<b>88</b>	5.1/8	16	65	2 *
	<b>140</b>	<b>78</b>	<b>88</b>	5.1/2	16	65	2 *
	<b>150</b>	<b>78</b>	<b>88</b>	6.	16	65	2 *

**Dynamic RS bits** are characterised by an ergonomically shaped mouthpiece. They lie perfectly in the horse's mouth resulting in soft and even pressure on the entire tongue area, encouraging the horse to chew. Dynamic RS bits stimulate the horse to accept the bit more easily.

In addition the ergonomically formed mouthpiece allows a rapid and balanced effect on the tongue. This bit supports the contact to the corners of the mouth in a very effective way, keeping the horse on the bit. At the same time the gentle joint in the middle which is angled forward by 45° makes it a very friendly bit.

Due to the curved joints the bit remains in the correct and central position on the tongue. The fine lozenge can direct gentle pressure pivotally onto the tongue. The bit encourages the confidence of the horse in the rider's hand and increases safety.

**Dynamic RS Loose Ring double jointed**
**SENSOGAN®  
AURIGAN®**

article no.	size (mm)	qualities available		size (inch)	thickness (mm)	ring-Ø (mm)	box quantity
<b>40424</b>	<b>115</b>	<b>78</b>	<b>88</b>	4.1/2	14	70	5 *
	<b>125</b>	<b>78</b>	<b>88</b>	5.	14	70	5 *
	<b>135</b>	<b>78</b>	<b>88</b>	5.1/4	14	70	5 *
	<b>145</b>	<b>78</b>	<b>88</b>	5.3/4	14	70	5 *
<b>40426</b>	<b>125</b>	<b>78</b>	<b>88</b>	5.	16	70	5 *
	<b>135</b>	<b>78</b>	<b>88</b>	5.1/4	16	70	5 *
	<b>145</b>	<b>78</b>	<b>88</b>	5.3/4	16	70	5 *

**Dynamic RS bradoon double jointed**
**SENSOGAN®  
AURIGAN®**

article no.	size (mm)	qualities available		size (inch)	thickness (mm)	ring-Ø (mm)	box quantity
<b>40214</b>	<b>105</b>	<b>78</b>	<b>88</b>	4.1/8	14	55	2
	<b>110</b>		<b>88</b>	4.1/4	14	55	2
<b>40215</b>	<b>115</b>	<b>78</b>	<b>88</b>	4.1/2	14	55	2
	<b>125</b>	<b>78</b>	<b>88</b>	5.	14	55	2 *
	<b>135</b>	<b>78</b>	<b>88</b>	5.1/4	14	55	2 *
	<b>145</b>	<b>78</b>	<b>88</b>	5.3/4	14	55	2 *
	<b>155</b>	<b>78</b>	<b>88</b>	6.1/8	14	55	2 *

**Dynamic RS Loose Ring single jointed**
**SENSOGAN®  
AURIGAN®**

The single jointed loose ring version of the successful double jointed Dynamic RS bits. The ergonomically formed mouthpiece allows a rapid and balanced effect on the tongue. In comparison to conventional single jointed bits the Dynamic RS mouthpieces give even pressure on the entire tongue area. Dynamic RS bits present a better contact between horse and rider. Brilliant for horses that are overactive in the mouth playing too much with the lozenge and therefore unresponsive to the signals of double jointed bits.

article no.	size (mm)	qualities available		size (inch)	thickness (mm)	ring-Ø (mm)	box quantity
<b>40422</b>	<b>115</b>	<b>78</b>	<b>88</b>	4.1/2	16	55	5 *
	<b>125</b>	<b>78</b>	<b>88</b>	5.	16	70	5 *
	<b>135</b>	<b>78</b>	<b>88</b>	5.1/4	16	70	5 *
	<b>145</b>	<b>78</b>	<b>88</b>	5.3/4	16	70	5 *

**Dynamic RS bradoon single jointed**
**SENSOGAN®  
AURIGAN®**

article no.	size (mm)	qualities available		size (inch)	thickness (mm)	ring-Ø (mm)	box quantity
<b>40215</b>	<b>120</b>	<b>78</b>	<b>88</b>	4.3/4	14	55	2 *
	<b>130</b>	<b>78</b>		5.1/8	14	55	2 *
	<b>140</b>	<b>78</b>	<b>88</b>	5.1/2	14	55	2 *
	<b>150</b>	<b>78</b>	<b>88</b>	6.	14	55	2 *

**Guenter Seidel**

"Having worked with Klaus Balkenhol for many years I am very pleased to also use Sprenger products. Sprenger seems to always have a solution for all situations and is far above the rest in quality, design and performance. I am honored to be associated with Sprenger products."

*Guenter Seidel*





**This bit is successfully used in practise to solve contact problems of the horse:**

“Using the single jointed SPRENGER **Dynamic RS I** have got the perfect bit for horses that tend to play with the mouthpiece. Due to the ergonomically formed design, it is easier to reach the correct contact. My horses more easily accept the bit and step into the hand more satisfied. Based on my experience Dynamic RS bits are the most innovative bits for training young horses and improving the communication with experienced sport horses. With very few exceptions I only use SPRENGER **Dynamic RS** bits for training my horses.”  
Alois Pollmann-Schweckhorst

**Dynamic RS**  
with flat rings, single jointed

**SENSOGAN®**  
**AURIGAN**

This version encourages the acceptance of the bit and rider’s contact in addition to the advantages mentioned above. The mouthpiece remains in a central position to direct gentle pressure perfectly on the tongue.



article no.	size (mm)	qualities available		size (inch)	thickness (mm)	ring-Ø (mm)	box quantity	
<b>40408</b>	<b>115</b>	<b>78</b>	<b>88</b>		4.1/2	16	65	2 *
	<b>125</b>	<b>78</b>	<b>88</b>		5.	16	65	2 *
	<b>135</b>	<b>78</b>	<b>88</b>		5.1/4	16	65	2 *
	<b>145</b>	<b>78</b>	<b>88</b>		5.3/4	16	65	2 *

**Dynamic RS**  
with small flat rings, single jointed

**SENSOGAN®**  
**AURIGAN**

article no.	size (mm)	qualities available		size (inch)	thickness (mm)	ring-Ø (mm)	box quantity	
<b>40245</b>	<b>115</b>	<b>78</b>	<b>88</b>		4.1/2	14	55	2 *
	<b>125</b>	<b>78</b>	<b>88</b>		5.	14	55	2 *
	<b>135</b>	<b>78</b>	<b>88</b>		5.1/4	14	55	2 *
	<b>145</b>	<b>78</b>	<b>88</b>		5.3/4	14	55	2 *

**Dynamic RS Eggbutt bradoon**  
with Eggbutt rings, single jointed

**SENSOGAN®**



article no.	size (mm)	qualities available		size (inch)	thickness (mm)	ring-Ø (mm)	box quantity	
<b>40249</b>	<b>115</b>	<b>78</b>			4.1/2	14	55	2 *
	<b>125</b>	<b>78</b>			5.	14	55	2 *
	<b>135</b>	<b>78</b>			5.1/4	14	55	2 *
	<b>145</b>	<b>78</b>			5.3/4	14	55	2 *

**Dynamic RS D-Ring**  
**double jointed**
**SENSOGAN®**

The D-Rings prevent the bit from being pulled through the horse's mouth. It lies steadily on the tongue encouraging a positive contact with the bit and the rider's hand therefore giving confidence to sensitive horses. The mouthpiece directs gentle pivotal pressure onto the horse's entire tongue enabling precise rein aids. It is more direct compared to a loose ring snaffle.

article no.	size (mm)	qualities available			size (inch)	thickness (mm)	ring-Ø (mm)	box quantity
40420	125	78			5.	14	80	2 *
	135	78			5.1/4	14	80	2 *
	145	78			5.3/4	14	80	2 *

**Dynamic RS Full Cheek**  
**double jointed**
**SENSOGAN®**

This bit lies very quietly in the horse's mouth as the cheeks prevent the bit from being pulled through the mouth. It avoids inconvenient pressure on the back teeth. The mouthpiece remains in the correct central position letting the rein aids work perfectly with the horse's mouth. The fine lozenge can direct gentle pressure pivotally onto the tongue. The cheeks are most helpful with turning aids especially with young horses. The gentle pressure against the face on the outside of the turn supports the rider's aid making turns much easier for the horse to understand and for the rider to carry out. The upper part of the cheeks are curved outwards away from the horse to avoid uncomfortable pressure on the jaws.

article no.	size (mm)	qualities available			size (inch)	thickness (mm)	ring-Ø (mm)	box quantity
41414	125	78			5.	16	50	2 *
	135	78			5.1/4	16	50	2 *
	145	78			5.3/4	16	50	2 *

**Dynamic RS Full cheek**  
**single jointed**
**SENSOGAN®**  
**AURIGAN**

This bit lies very quietly in the horse's mouth as the cheeks prevent the bit from being pulled through the mouth. It avoids inconvenient pressure on the back teeth. The mouthpiece remains in the correct central position letting the rein aids work perfectly with the horse's mouth. Brilliant for horses that are overactive in the mouth playing too much with the lozenge and therefore unresponsive to the signals of double jointed bits. The cheeks are most helpful with turning aids especially with young horses. The gentle pressure against the face on the outside of the turn supports the rider's aid making turns much easier for the horse to understand and for the rider to carry out. The upper part of the cheeks are curved outwards away from the horse to avoid uncomfortable pressure on the jaws.

article no.	size (mm)	qualities available			size (inch)	thickness (mm)	ring-Ø (mm)	box quantity
41422	115		88		4.1/2	16	50	2 *
	125	78	88		5.	16	50	2 *
	135	78	88		5.1/4	16	50	2 *
	145		88		5.3/4	16	50	2 *





**Dynamic RS Universal**  
double jointed

SENSOGAN®

This bit is extremely versatile due to the different rein options. In addition the ergonomically formed mouthpiece allows a rapid and balanced effect on the tongue. The lever action has a slight delay due to the lateral offset position of the upper ring. Riders can additionally add a curb strap (Art. 42111) to get more direct action. The pressure on the poll is limited that way.

article no.	size (mm)	qualities available		size (inch)	thickness (mm)	ring-Ø (mm)	box quantity
40626	125	78		5.	16	70	2 *
	135	78		5.1/4	16	70	2 *
	145	78		5.3/4	16	70	2 *
42111	000	00		black / length: 59 cm			5



**Dynamic RS short shank Pelham**  
double jointed

SENSOGAN®  
AURIGAN®

Brilliant for sensitive horses. The mouthpiece perfectly follows the anatomy of the mouth to improve the horse's willingness and cooperation. The rein aids come into play earlier due to the lever action of the short cheeks. The best choice for strong but sensitive horses as the ergonomically formed mouthpiece enables an even distribution of gentle pressure onto the tongue.

article no.	size (mm)	qualities available		size (inch)	thickness (mm)	cheek (cm)	lower cheeks (cm)	box quantity
42014	115	78	88	4.1/2	16	10	4,5	2 *
	125	78		5.	16	10	4,5	2 *
	135	78		5.1/4	16	10	4,5	2 *
	145	78	88	5.3/4	16	10	4,5	2 *
	155	78	88	6.1/8	16	10	4,5	2 *

**Pelham bit converters (by pair)**, leather with nylon rope / length: 16 cm

42112	000	00		black				5 *
	001	00		dark brown				5 *

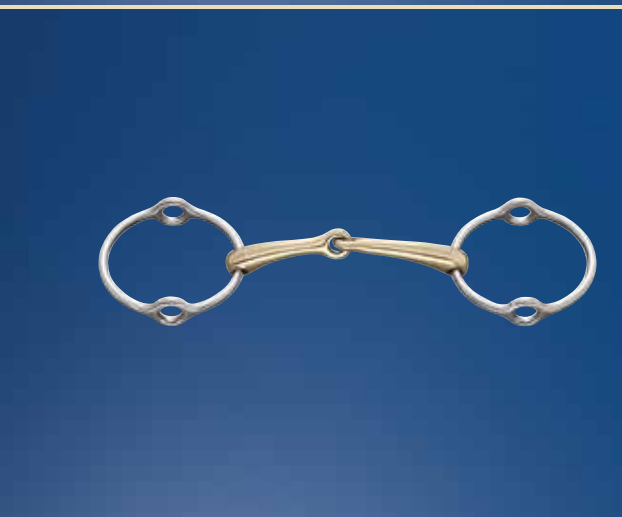

**Dynamic RS Gag bit**  
single jointed

SENSOGAN®

With the use of 2 reins in combination with a special cheekpiece for gag bits this bit enables an effective and precise control on the horse's mouth and poll. Particularly suitable for horses that tend to push forward, the pressure on the poll that the rider achieves gives maximum control. The ergonomically formed mouthpiece allows a rapid and balanced effect on the tongue. In comparison to conventional single jointed bits the Dynamic RS mouthpieces give even pressure on the entire tongue area. Gag bits are very popular in the fields of Jumping and Polo.

article no.	size (mm)	qualities available		size (inch)	thickness (mm)	ring-Ø (mm)	box quantity
40441	125	78		5.	16	80	2 *
	135	78		5.1/4	16	80	2 *
	145	78		5.3/4	16	80	2 *

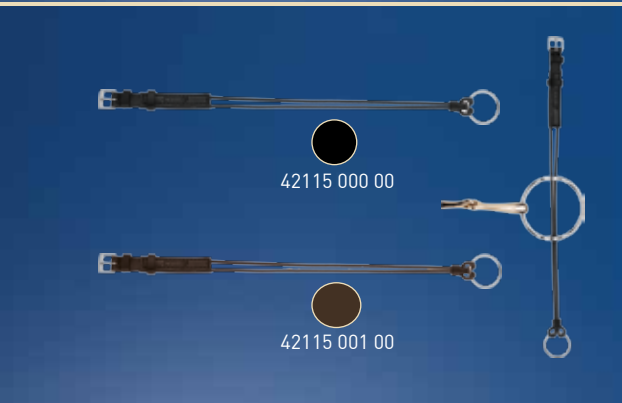

**Gag cheeks (by pair)**

with HS Logo on the leather part

article no.	size (mm)	qualities available		colour	box quantity
<b>Leather with nylon rope round webbed – length: 45 cm</b>					
42115	000	00		black	1 *
	001	00		dark brown	1 *



**Dynamic RS Multi Ring snaffle**  
**single jointed**

SENSOGAN®

The special effect of these bits is the three different possibilities of attaching the reins. Depending on purpose and education level they enable versatile application possibilities.

**Different rein options:**

1. Effect of a normal loose ring snaffle.
2. Additional gentle pressure on the poll.
3. Additional gentle pressure onto tongue and lower jaw.

article no.	size (mm)	qualities available	size (inch)	thickness (mm)	ring-Ø (mm)	box quantity
40452	115	78	4.1/2	16	70	2
	125	78	5	16	70	2 *
	135	78	5.1/4	16	70	2 *
	145	78	5.3/4	16	70	2 *

**Dynamic RS Multi Ring snaffle**  
**double jointed**

SENSOGAN®

The special effect of these bits is the three different possibilities of attaching the reins. Depending on purpose and education level they enable versatile application possibilities.

**Different rein options:**

1. Effect of a normal loose ring snaffle.
2. Additional gentle pressure on the poll.
3. Additional gentle pressure onto tongue and lower jaw.

article no.	size (mm)	qualities available	size (inch)	thickness (mm)	ring-Ø (mm)	box quantity
40466	125	78	5	16	70	2 *
	135	78	5.1/4	16	70	2 *
	145	78	5.3/4	16	70	2 *

**Ruth Edge**

“For me the Sprenger bits give me the ultimate feel and connection with my horse’s mouth and the quality is second to none.”



**Lisa Wilcox**

“Sprenger have proven to be the best through their high quality and innovation, producing new products that are improving the way the riders communicate with their horse. It has been a great experience for me to be able to share my ideas and concepts with Sprenger. Together with Sprenger we developed the WH ULTRA bit which I am thrilled with, my horses love it! Only the best for me and my horses!”

*Lisa Wilcox*

**A double jointed bit, angled forward by 45°, that features a unique roller in the center section.**

WH ULTRA bits – developed by SPRENGER in cooperation with Lisa Wilcox and Ernst Hoyos.

“This unique roller provides a gentle stimulation to the tongue, which encourages the horse to chew, prompting salivation, allowing the acceptance of the bit therefore the relaxation of the jaw. It has been Ernst’s and my experience that through this gentle stimulation our horses learn more quickly to accept the bit softening their entire top-line enabling us to perform the movements with more relaxation, throughness and ultimately more harmony.” (Lisa Wilcox)



**WH ULTRA Snaffle**

This bit uses the tongue’s sense of touch to achieve optimum effect without being sharp.

**WH ULTRA soft Snaffle**

A different variation of the approved KK ULTRA bits: the center section is provided with a soft but durable rubber cover. Helps to introduce a horse more easily to the bit. The aids given with the reins are carefully directed to the horse’s tongue resulting in prompt chewing activity, thus causing relaxed and contented horses. This bit can help to prevent tongue problems and teeth-grinding in an ideal way.

European patent no. EP 1 718 561 B1 / EP 1 140 693 B1  
US patent no. US 6,425,229 B2 / US 7,481,034 B2



**Make sure that the arrow is pointing forwards on the left hand side.**

**WH ULTRA**
**SENSOGAN®**  
**AURIGAN**

The KK ULTRA mouthpiece with the middle link turned forward by 45° provides gentle but effective communication with the horse. The additional feature of the WH ULTRA bits is a unique roller in the center section that brings an even better focus for the horse onto the tongue.

The WH ULTRAS are highly recommended for horses that are unresponsive to the rein aids. The tongue is gently stimulated to utilise its highly sensitive sense of touch in an incomparable way. The horse gets relaxed and stays focused on the tongue preventing it from being easily distracted and so more responsive to the rein aids of the rider.

article no.	size (mm)	qualities available			size (inch)	thickness (mm)	ring-Ø (mm)	box quantity
<b>40609</b>	<b>120</b>	<b>78</b>			4.3/4	16	70	5 *
	<b>130</b>	<b>78</b>			5.1/8	16	70	5 *
	<b>140</b>	<b>78</b>			5.1/2	16	70	5 *
	<b>150</b>	<b>78</b>			6.	16	70	5 *
<b>40610</b>	<b>120</b>	<b>78</b>	<b>88</b>		4.3/4	18	70	5 *
	<b>130</b>	<b>78</b>	<b>88</b>		5.1/8	18	70	5 *
	<b>140</b>	<b>78</b>	<b>88</b>		5.1/2	18	70	5 *

**WH ULTRA bradoon**
**SENSOGAN®**  
**AURIGAN**

article no.	size (mm)	qualities available			size (inch)	thickness (mm)	ring-Ø (mm)	box quantity
<b>40227</b>	<b>120</b>	<b>78</b>	<b>88</b>		4.3/4	14	55	2 *
	<b>130</b>	<b>78</b>	<b>88</b>		5.1/8	14	55	2 *
	<b>140</b>	<b>78</b>			5.1/2	14	55	2 *
	<b>150</b>		<b>88</b>		6.	14	55	2
<b>40226</b>	<b>120</b>	<b>78</b>			4.3/4	16	55	2 *
	<b>130</b>	<b>78</b>	<b>88</b>		5.1/8	16	55	2 *
	<b>140</b>	<b>78</b>	<b>88</b>		5.1/2	16	55	2 *
	<b>150</b>	<b>78</b>	<b>88</b>		6.	16	55	2 *

**WH ULTRA D-Ring**
**SENSOGAN®**

Gives unbalanced and wilful horses more confidence as it supports the contact with the bit and remains steady in the mouth. The D-Rings prevent the bit from being pulled through the horse's mouth and support sideways acting rein aids.

article no.	size (mm)	qualities available			size (inch)	thickness (mm)	ring-Ø (mm)	box quantity
<b>40415</b>	<b>125</b>	<b>78</b>			5.	16	80	2 *
	<b>135</b>	<b>78</b>			5.1/4	16	80	2 *
	<b>145</b>	<b>78</b>			5.3/4	16	80	2 *

**WH ULTRA soft**

**SENSOGAN®**  
**AURIGAN**

Brilliant to introduce young horses to the bit and also for older horses that may be "bit-shy" and need to be more relaxed. The approved KK ULTRA bit design provided the basis for these bits. The center section has an additional covering of soft but durable rubber so the rein aids can be extremely soft. It also helps to avoid bad habits like teeth grinding through its relaxing effect on horses.

article no.	size (mm)	qualities available			size (inch)	thickness (mm)	ring-Ø (mm)	box quantity
<b>40612</b>	<b>120</b>	<b>78</b>	<b>88</b>		4.3/4	16	70	5 *
	<b>130</b>	<b>78</b>			5.1/8	16	70	5 *
	<b>140</b>	<b>78</b>			5.1/2	16	70	5 *





SPRENGER

**noyo**contact



# Uniquely shaped, especially sensitive.

SPRENGER introduces its  
latest invention in bit design.

**novocontact bits** are designed to create a unique oval shape which widens the contact surface on the tongue while the rider keeps a steady contact. As the rider gives a rein aid the mouthpiece turns forward and the contact surface gets narrower, ensuring more precise and effective communication. **novocontact bits** improve the interaction between horse and rider for a better contact and acceptance of the bit.

## Extensively tested and highly recommended.

Tests have shown that the **single jointed novocontact bits** are highly recommended for horses that do not take the contact confidently. They also provide added benefit for horses with a sensitive mouth, since the rider is able to give precise but soft aids.

The **double jointed novocontact bits** are also ideal to use on horses that occasionally tend to pull against the hand, but are too sensitive to be ridden with stronger bits.

**novocontact bits** are based on the latest scientific research and are suitable for every type of horse. The bits have been successfully tested and approved by professional and leisure riders.

**novocontact bits** are now available in single and double jointed versions.

European patent no. EP 1 140 693 B1  
US patent no. US 6,425,229 B2

SENSOGAN®



Make sure that the arrow  
is pointing forwards on  
the left hand side.

## NOVOCONTACT BITS - DOUBLE JOINTED

Tests have shown that the **double jointed novocontact bits** are also ideal to use on horses that occasionally tend to pull against the hand, but are too sensitive to be ridden with stronger bits.



### novocontact Loose Ring snaffle

SENSOGAN®

The double jointed novocontact loose ring snaffle is recommended for sensitive horses that occasionally tend to pull against the bit.

article no.	size (mm)	qualities available	size (inch)	thickness (mm)	ring-Ø (mm)	box quantity
40456	115	78	4.1/2	16	70	2 *
	125	78	5.	16	70	2 *
	135	78	5.1/4	16	70	2 *
	145	78	5.3/4	16	70	2 *



### novocontact bradoon

SENSOGAN®

The novocontact bradoon has a large contact surface despite of the relative thin thickness of 12mm. In combination with a Weymouth the innovative shape of this bit enables the optimal utilisation of the limited space in the horse's mouth resulting in particularly soft impact.

article no.	size (mm)	qualities available	size (inch)	thickness (mm)	ring-Ø (mm)	box quantity
40256	115	78	4.1/2	12	55	2 *
	125	78	5.	12	55	2 *
	135	78	5.1/4	12	55	2 *
	145	78	5.3/4	12	55	2 *



### novocontact snaffle with flat rings

SENSOGAN®

The mouthpiece is fixed to the rings, keeping the bit steady in the horse's mouth and therefore ensuring more precise and direct impact on the tongue compared to a loose ring snaffle. Due to the smooth transitions to the side parts it is especially protecting the mouth corners. Furthermore, the additional contact surface from the cheeks on the mouth corners supports guarding and sideways acting rein aids.

article no.	size (mm)	qualities available	size (inch)	thickness (mm)	ring-Ø (mm)	box quantity
40356	115	78	4.1/2	16	65	2 *
	125	78	5.	16	65	2 *
	135	78	5.1/4	16	65	2 *
	145	78	5.3/4	16	65	2 *



### novocontact short shank Pelham

SENSOGAN®

When using a Pelham the rein aid is distributed to three various parts of the horse's head: the tongue, the poll and the lower jaw. This enables the rider to get more control over strong and powerful horses. As the chin is very sensitive and only covered with a thin layer of skin it makes sense to use a curb chain guard as a cushion.

article no.	size (mm)	qualities available	size (inch)	thickness (mm)	cheek (cm)	lower cheeks (cm)	box quantity
42156	125	78	5.	16	10	4,5	2 *
	135	78	5.1/4	16	10	4,5	2 *
	145	78	5.3/4	16	10	4,5	2 *



## NOVOCONTACT BITS - SINGLE JOINTED

Tests have shown that the **single jointed novocontact bits** are highly recommendable for horses that do not take the contact confidently. They also provide added benefit for horses with a sensitive mouth, since the rider is able to give precise but soft aids.

### novocontact Loose Ring snaffle

SENSOGAN®

The single jointed novocontact loose ring snaffle is highly recommendable for horses with a sensitive mouth that do not take the contact confidently.

article no.	size (mm)	qualities available			size (inch)	thickness (mm)	ring-Ø (mm)	box quantity
40540	115	78			4.1/2	16	70	2 *
	125	78			5.	16	70	2 *
	135	78			5.1/4	16	70	2 *
	145	78			5.3/4	16	70	2 *



### novocontact bradoon

SENSOGAN®

The novocontact bradoon has a large contact surface despite of the relative thin thickness of 12mm. In combination with a Weymouth the innovative shape of this bit enables the optimal utilisation of the limited space in the horse's mouth resulting in particularly soft impact.

article no.	size (mm)	qualities available			size (inch)	thickness (mm)	ring-Ø (mm)	box quantity
40240	115	78			4.1/2	12	55	2 *
	125	78			5.	12	55	2 *
	135	78			5.1/4	12	55	2 *
	145	78			5.3/4	12	55	2 *



### novocontact snaffle with flat rings

SENSOGAN®

The mouthpiece is fixed to the rings, keeping the bit steady in the horse's mouth and therefore ensuring more precise and direct impact on the tongue compared to a loose ring snaffle. Due to the smooth transitions to the side parts it is especially protecting the mouth corners. Furthermore, the additional contact surface from the cheeks on the mouth corners supports guarding and sideways acting rein aids.

article no.	size (mm)	qualities available			size (inch)	thickness (mm)	ring-Ø (mm)	box quantity
40344	115	78			4.1/2	16	65	2 *
	125	78			5.	16	65	2 *
	135	78			5.1/4	16	65	2 *
	145	78			5.3/4	16	65	2 *



### novocontact short shank Pelham

SENSOGAN®

When using a Pelham the rein aid is distributed to three various parts of the horse's head: the tongue, the poll and the lower jaw. This enables the rider to get more control over strong and powerful horses. As the chin is very sensitive and only covered with a thin layer of skin it makes sense to use a curb chain guard as a cushion.

article no.	size (mm)	qualities available			size (inch)	thickness (mm)	cheek (cm)	lower cheeks (cm)	box quantity
42540	125	78			5.	16	10	4,5	2 *
	135	78			5.1/4	16	10	4,5	2 *
	145	78			5.3/4	16	10	4,5	2 *





### Eggbutt Mullen Mouth hard carbon with oval stainless steel rings

This unjointed bit with a straight, pole mouthpiece disperses pressure on the whole tongue width and the lower jaw bones. The bit may help when riding horses that tend to back off from the riders aids, for example when cantering to a fence. Eggbutts are suitable for horses with sensitive corners on their mouths, as they prevent them from being pinched which can happen with loose ring snaffles.

article no.	size (mm)	qualities available		size (inch)	thickness (mm)	ring-Ø (mm)	box quantity
40860	125	56		5.	16	55	2 *
	135	56		5.1/4	16	55	2 *
	145	56		5.3/4	16	55	2 *



### Duo Loose Ring (Info p.44) flexible plastic mouthpiece reinforced with a stainless steel cable

This bit can be used on both sides, either as a straight bar or with a low port that leaves space for the tongue.

article no.	size (mm)	qualities available		size (inch)	thickness (mm)	ring-Ø (mm)	box quantity
40801	115	00		4.1/2	16	55	5 *
	125	00		5.	16	70	5 *
	135	00		5.1/4	16	70	5 *
	145	00		5.3/4	16	70	5 *



### Rubber Mullen Mouth bit flexible, reinforced with a stainless steel cable

article no.	size (mm)	qualities available		size (inch)	thickness (mm)	ring-Ø (mm)	box quantity
40842	125	55		5.	20	70	5
	135	55		5.1/4	20	70	5
	145	55		5.3/4	20	70	5



### Flex Control – the flexible mullen mouth (straight bar) **SENSOGAN®** **AURIGAN®**

The Flex Control is a single jointed bit. The metal joint is covered with a soft and flexible rubber coat in order to protect tender mouth spots of sensitive horses. The moveable rubber part enables the rider to achieve optimal thoroughness and contact to the horse.

article no.	size (mm)	qualities available		size (inch)	thickness (mm)	ring-Ø (mm)	box quantity
40530	125	78	88	5.	18	70	2 *
	135	78	88	5.1/4	18	70	2 *
	145	78	88	5.3/4	18	70	2 *

**Mullen Mouth Loose Ring**

SENSOGAN®  
AURIGAN™

This unjointed bit with a straight, pole mouthpiece disperses pressure on the whole tongue width and the lower jaw bones. If the rider gives too strong aids with only one rein, the bit might tilt. Therefore it is only to be used by sensitive riders. The bit may help when riding horses that tend to back off the riders aids, for example when cantering to a fence.

article no.	size (mm)	qualities available		size (inch)	thickness (mm)	ring-Ø (mm)	box quantity
40582	125	78	88	5.	16	70	2 *
	135	78	88	5.1/4	16	70	2 *
	145	78	88	5.3/4	16	70	2 *



**CM Mullen Mouth snaffle**

SENSOGAN®  
AURIGAN™

**Often used for correction of tongue vices**

Comfort Mouth – the name speaks for itself. The mouthpiece provides the horse with ultimate comfort and makes it accepting the rider's hand. The port offers broad space for long and fleshy tongues. The bit helps to prevent tongue vices in an ideal way.

article no.	size (mm)	qualities available		size (inch)	thickness (mm)	ring-Ø (mm)	box quantity
40583	110	78	88	4.1/4	16	70	2 *
	120	78	88	4.3/4	16	70	2 *
	130	78	88	5.1/8	16	70	2 *
	140	78	88	5.1/2	16	70	2 *



**KK Correction bit**

SENSOGAN®  
AURIGAN™

**Often used for correction of tongue vices**

An unjointed bit with an anatomically formed port. Gives immediate improvement to horses that are too strong or wilful. When the reins are pulled the bit provides direct and "spotty" pressure on the tongue due to its special shape enabling precise aids.

article no.	size (mm)	qualities available		size (inch)	thickness (mm)	ring-Ø (mm)	box quantity
40502	120	78	88	4.3/4	18	70	2 *
	130	78	88	5.1/8	18	70	2 *
	140	78	88	5.1/2	18	70	2 *



**KK Schooling bit**

AURIGAN™

The schooling bit helps to introduce a horse gently to unjointed bits. The unique bar design offers room for the tongue and adapts perfectly to the horse's mouth. The curved endings of the mouthpiece embrace the cheeks and give an extremely steady fit in combination with the eggbutt rings. The schooling bit has a very direct action and introduces the horse for future use of Weymouths.

article no.	size (mm)	qualities available		size (inch)	thickness (mm)	ring-Ø (mm)	box quantity
40501	120		88	4.3/4	18	55	2
	130		88	5.1/8	18	55	2
	140		88	5.1/2	18	55	2





TURNADO bits present a new generation of loose ring snaffles having the mouthpiece turned forward by 45°.



This special rotation is distinctly marked by a slightly abrasive surface in the middle part of the mouthpiece. Due to the innovatively adjusted mouthpiece the rein aids reach the horse's mouth precisely, but in a soft way as the pressure is evenly distributed on the tongue. TURNADO bits enable perfect communication with the horse as prompt and ideal chewing activity is provided immediately. This bit can also help prevent tongue vices.

**Advantages of TURNADO bits:**

- patented, innovative design with 45° angle
- lies perfectly in the horse's mouth
- perfect communication between rider and horse
- helps to prevent tongue vices
- large variety of products

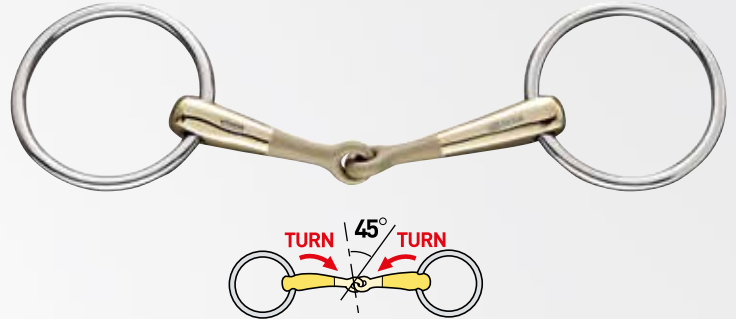

European patent no. EP 1 773 713 B1 / EP 1 140 693 B1  
 US patent no. US 7,775,023 B2 / US 6,425,229 B2



**TURNADO Loose Ring snaffle**

SENSOGAN®  
 AURIGAN

article no.	size (mm)	qualities available		size (inch)	thickness (mm)	ring-Ø (mm)	box quantity
40587	110	78	88	4.1/4	16	55	5
	115	78	88	4.1/2	16	55	5
	125	78	88	5.	16	70	5 *
	135	78	88	5.1/4	16	70	5 *
	145	78	88	5.3/4	16	70	5 *
	155	78	88	6.1/8	16	70	5 *
40588	125	78	88	5.	18	70	5 *
	135	78		5.1/4	18	70	5 *
	145	78	88	5.3/4	18	70	5 *



**TURNADO bradoon**

SENSOGAN®  
 AURIGAN

article no.	size (mm)	qualities available		size (inch)	thickness (mm)	ring-Ø (mm)	box quantity
40286	125	78	88	5	14	55	2 *
	135	78	88	5.1/4	14	55	2 *
	145	78		5.3/4	14	55	2 *
	155	78	88	6.1/8	14	55	2 *



**TURNADO Loose Ring snaffle stainless steel**



article no.	size (mm)	qualities available		size (inch)	thickness (mm)	ring-Ø (mm)	box quantity
40587	115	56		4.1/2	16	55	5
	125	56		5.	16	70	5
	135	56		5.1/4	16	70	5
	145	56		5.3/4	16	70	5
	155	56		6.1/8	16	70	5

**TURNADO 2-TYPE**  
Eggbutt bit with loose rings



This bit combines the advantages of a loose ring snaffle and the lateral contact of an eggbutt. Due to the eggbutt shape it is gentle on the corners of the mouth and the anatomically formed mouthpiece perfectly ensuring gentle pressure and precise rein aids. Additionally, the TURNADO 2-TYPE maintains the lightness of a loose ring snaffle.

article no.	size (mm)	qualities available		size (inch)	thickness (mm)	ring-Ø (mm)	box quantity
40589	125	78	88	5.	16	70	2 *
	135	78		5.1/4	16	70	2 *
	145	78	88	5.3/4	16	70	2 *



**TURNADO Full Cheek Gag**



The favourite choice of show jumpers as the control enables challenging courses to be jumped with ease. The TURNADO mouthpiece enables precise rein aids especially as the directional control is reinforced by the full cheeks. The use of the second rein in combination with a cheek piece for gag bits enables the rider to increase the pressure on the horse's poll. Highly recommended to cope with the most technical challenges in any show jumping course.

article no.	size (mm)	qualities available		size (inch)	thickness (mm)	ring-Ø (mm)	box quantity
41588	125	78		5.	18	60	1 *
	135	78	88	5.1/4	18	60	1 *
	145	78		5.3/4	18	60	1 *



Gag cheeks (by pair), Leather with nylon rope round webbed

42115	000	00			colour: black / length: 45 cm	1 *
	001	00			colour: dark brown / length: 45 cm	1 *



**TURNADO short shank Pelham**



A soft Pelham as the mouthpiece is a better fit for the horse's anatomy in contrast to conventional single jointed bits. The horse's willingness to cooperate is optimised and the rein aids come into play earlier due to the short cheeks. A good choice for strong horses that can be unresponsive to the signals of double jointed bits.

article no.	size (mm)	qualities available		size (inch)	thickness (mm)	cheek (cm)	lower cheeks (cm)	box quantity
42087	125		88	5.	16	10	4,5	2
	135		88	5.1/4	16	10	4,5	2
	145		88	5.3/4	16	10	4,5	2



Pelham bit converters (by pair), leather with nylon rope / length: 16 cm

42112	000	00			black	5 *
	001	00			dark brown	5 *



**Loose Ring snaffles**

Loose Ring snaffles are the most common types of bit. They provide direct pressure without leverage. When the reins are pulled the rider's aids are directed onto the tongue and its edges. Loose ring snaffles are available in highly diverse shapes and materials. The best known types are single and double jointed versions. On pages 11 to 28 double jointed snaffles are explained in detail.



SENSOGAN®  
AURIGAN™

article no.	size (mm)	qualities available		size (inch)	thickness (mm)	ring-Ø (mm)	box quantity
40556	125	78	88	5.	14	70	5 *
	135	78	88	5.1/4	14	70	5 *
	145	78	88	5.3/4	14	70	5 *



SENSOGAN®

article no.	size (mm)	qualities available		size (inch)	thickness (mm)	ring-Ø (mm)	box quantity
40531	120	78		4.3/4	16	70	5 *
	130	78		5.1/8	16	70	5 *
	140	78		5.1/2	16	70	5 *
	150	78		6.	16	70	5 *



SENSOGAN®  
AURIGAN™

article no.	size (mm)	qualities available		size (inch)	thickness (mm)	ring-Ø (mm)	box quantity
40552	125	78	79 88	5.	18	70	5 *
	135	78	79 88	5.1/4	18	70	5 *
	145	78	79 88	5.3/4	18	70	5 *



SENSOGAN®  
AURIGAN™

article no.	size (mm)	qualities available		size (inch)	thickness (mm)	ring-Ø (mm)	box quantity
40652	125	78	88	5.	20	70	5
	135		88	5.1/4	20	70	5
	145	78	88	5.3/4	20	70	5



**KK snaffle, anatomically shaped**  
also available as a bradoon (see p.63)

SENSOGAN®

article no.	size (mm)	qualities available		size (inch)	thickness (mm)	ring-Ø (mm)	box quantity
40512	130	78		5.1/8	16	70	5 *
	140	78		5.1/2	16	70	5 *
	150	78		6.	16	70	5 *
40511	125	78		5.	18	70	5 *
	135	78		5.1/4	18	70	5 *
	145	78		5.3/4	18	70	5 *



**Loose Ring snaffle**  
slanting mouthpiece

AURIGAN™

article no.	qualities available		size (inch)	thickness (mm)	ring-Ø (mm)	box quantity
40565	135	88	5.1/4	18	70	5
	145	88	5.3/4	18	70	5 *



Loose Ring snaffle, double jointed



article no.	size (mm)	qualities available	size (inch)	thickness (mm)	ring-Ø (mm)	box quantity
40905	115	56	4.1/2	16	55	5 *
	125	56	5.	16	70	5 *
	135	56	5.1/4	16	70	5 *
	145	56	5.3/4	16	70	5 *
40908	125	56	5.	18	70	5 *
	135	56	5.1/4	18	70	5 *
	145	56	5.3/4	18	70	5 *



TURNADO Loose Ring snaffle



article no.	size (mm)	qualities available	size (inch)	thickness (mm)	ring-Ø (mm)	box quantity
40587	115	56	4.1/2	16	55	5
	125	56	5.	16	70	5
	135	56	5.1/4	16	70	5
	145	56	5.3/4	16	70	5
	155	56	6.1/8	16	70	5

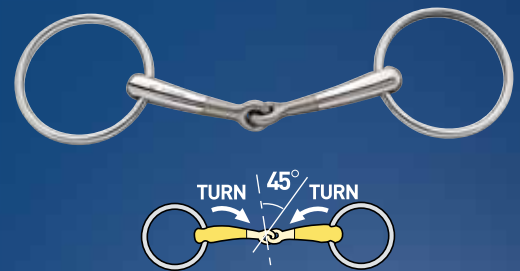

Loose Ring snaffle



article no.	size (mm)	qualities available	size (inch)	thickness (mm)	ring-Ø (mm)	box quantity
40620	115	56	4.1/2	18	55	5
	125	56	5.	18	65	5 *
	135	56	5.1/4	18	65	5 *
	145	56	5.3/4	18	65	5 *
	160	56	6.1/4	18	65	5



Loose Ring snaffle for ponies



article no.	size (mm)	qualities available	size (inch)	thickness (mm)	ring-Ø (mm)	box quantity
40112	095	56	3.3/4	14	45	5
	105	56	4.1/8	14	45	5
	115	56	4.1/2	14	45	5
40202	095	56	3.3/4	14	40	2
	100	56	4.	14	40	2
	115	56	4.1/2	14	55	2



Eggbutt bits

Highly recommended for horses that are unsteady in the contact with the bit. Eggbutts are suitable for horses with sensitive corners on their mouths, as they prevent them from being pinched which can happen with loose ring snaffles. The characteristic features of these bits are the oval rings (resp. the D-Ring side parts) which are fixed to the mouthpiece, keeping the bit steady in the mouth, enabling direct and effective impact onto the tongue. The side parts also prevent the bit from being pulled through the mouth. The additional contact surface from the cheeks on the mouth corners supports guarding and sideways acting rein aids.



**KK ULTRA Eggbutt** (Info page 13)  
double jointed



article no.	size (mm)	qualities available		size (inch)	thickness (mm)	ring-Ø (mm)	box quantity
40366	125	78	89	5.	18	70	2 *
	135	78	89	5.1/4	18	70	2 *
	145	78		5.3/4	18	70	2 *



**Eggbutt**



article no.	size (mm)	qualities available		size (inch)	thickness (mm)	ring-Ø (mm)	box quantity
40378	125	78		5.	16	70	2 *
	135	78		5.1/4	16	70	2 *
	145	78		5.3/4	16	70	2 *



**Eggbutt**  
double jointed, stainless steel



article no.	size (mm)	qualities available		size (inch)	thickness (mm)	ring-Ø (mm)	box quantity
40377	115	56		4.1/2	16	65	2
	125	56		5.	16	65	2
	135	56		5.1/4	16	65	2
	145	56		5.3/4	16	65	2



**Eggbutt**  
stainless steel



article no.	size (mm)	qualities available		size (inch)	thickness (mm)	ring-Ø (mm)	box quantity
40376	115	56		4.1/2	16	55	2
	125	56		5.	16	65	2
	135	56		5.1/4	16	65	2
	145	56		5.3/4	16	65	2



**Eggbutt**  
hollow mouthpiece, stainless steel



article no.	size (mm)	qualities available		size (inch)	thickness (mm)	ring-Ø (mm)	box quantity
40380	125	56		5.	18	65	2
	135	56		5.1/4	18	65	2
	145	56		5.3/4	18	65	2

**Eggbutt bit, single jointed**  
hard carbon with oval stainless steel rings

Smooth single jointed hard carbon mouthpiece which acts mainly on the tongue borders enabling precise rein aids. The small eggbutt style rings are particularly suitable for horses with sensitive mouth corners as they prevent the flews from being pinched.

article no.	size (mm)	qualities available	size (inch)	thickness (mm)	ring-Ø (mm)	box quantity
40861	125	56	5.	16	55	2
	135	56	5.1/4	16	55	2
	145	56	5.3/4	16	55	2



**Eggbutt Gag bit, single jointed**  
hard carbon with stainless steel gag rings

The use of the second rein in combination with a cheek piece for gag bits enables effective and targeted impact onto mouth and poll. Suitable for strong horses that tend to push forward. Gag bits are the favorite choice among show jumpers and polo players.

article no.	size (mm)	qualities available	size (inch)	thickness (mm)	ring-Ø (mm)	box quantity
40863	125	56	5.	16	55	2
	135	56	5.1/4	16	55	2
	145	56	5.3/4	16	55	2

Gag cheeks (by pair), Leather with nylon rope round webbed

42115	000	00	colour: black / length: 45 cm			1 *
	001	00	colour: dark brown / length: 45 cm			1 *



**Eggbutt Mullen Mouth**  
hard carbon with oval stainless steel rings

This unjointed bit with a straight, pole mouthpiece disperses pressure on the whole tongue width and the lower jaw bones. The bit may help when riding horses that tend to back off from the riders aids, for example when cantering to a fence. Eggbutts are suitable for horses with sensitive corners on their mouths, as they prevent them from being pinched which can happen with loose ring snaffles.

article no.	size (mm)	qualities available	size (inch)	thickness (mm)	ring-Ø (mm)	box quantity
40860	125	56	5.	16	55	2 *
	135	56	5.1/4	16	55	2 *
	145	56	5.3/4	16	55	2 *



**Eggbutt Mullen Mouth Gag bit**  
hard carbon with stainless steel gag rings

The use of the second rein in combination with a cheek piece for gag bits enables effective and targeted impact onto mouth and poll. Suitable for strong horses that tend to push forward. Gag bits are the favorite choice among show jumpers and polo players.

article no.	size (mm)	qualities available	size (inch)	thickness (mm)	ring-Ø (mm)	box quantity
40862	125	56	5.	16	55	2
	135	56	5.1/4	16	55	2
	145	56	5.3/4	16	55	2

Gag cheeks (by pair), Leather with nylon rope round webbed

42115	000	00	colour: black / length: 45 cm			1 *
	001	00	colour: dark brown / length: 45 cm			1 *





**D-Ring snaffles**

D-Rings prevent the bit from being pulled through the horse's mouth so it lies more steadily on the tongue giving a more comfortable feeling. Gentle pressure is pivoted directly onto the tongue ensuring light and precise rein aids. The fixed rings enable the rider to have a good contact with the bit. The additional contact surface from the cheeks on the mouth corners supports guarding and sideways acting rein aids.



**KK ULTRA D-Ring**



SENSOGAN®

The D-Rings prevent the bit from being pulled through the horse's mouth so it lies more steadily on the tongue giving a more comfortable feeling. Gentle pressure is pivoted directly onto the tongue ensuring light and precise rein aids. The fixed rings enable the rider a good contact with the bit.

article no.	size (mm)	qualities available	size (inch)	thickness (mm)	ring-Ø (mm)	box quantity
40416	125	78	5.	15	80	2 *
	135	78	5.1/4	15	80	2 *
	145	78	5.3/4	15	80	2 *
	155	78	6.1/8	15	80	2 *



**WH ULTRA D-Ring**



SENSOGAN®

Gives unbalanced and wilful horses more confidence as it supports the contact with the bit and remains steady in the mouth. The D-Rings prevent the bit from being pulled through the horse's mouth.

article no.	size (mm)	qualities available	size (inch)	thickness (mm)	ring-Ø (mm)	box quantity
40415	125	78	5.	16	80	2 *
	135	78	5.1/4	16	80	2 *
	145	78	5.3/4	16	80	2 *



**Dynamic RS D-Ring**



SENSOGAN®

The D-Rings prevent the bit from being pulled through the horse's mouth. It lies steadily on the tongue encouraging a positive contact with the bit and the rider's hand therefore giving confidence to sensitive horses. The mouthpiece directs gentle pivotal pressure onto the horse's entire tongue enabling precise rein aids. It is more direct compared to a loose ring snaffle.

article no.	size (mm)	qualities available	size (inch)	thickness (mm)	ring-Ø (mm)	box quantity
40420	125	78	5.	14	80	2 *
	135	78	5.1/4	14	80	2 *
	145	78	5.3/4	14	80	2 *



**KK D-Ring**



SENSOGAN®

The D-Rings prevent the bit from being pulled through the horse's mouth. It therefore lies steadily on the tongue. Gentle pivotal pressure is placed on the tongue ensuring light and precise rein aids. The fixed rings make it more direct than a loose ring snaffle. The special shape of the mouthpiece provides precise rein aids. The curved arms of the mouthpiece avoid uncomfortable pressure on the sensitive borders of the tongue.

article no.	size (mm)	qualities available	size (inch)	thickness (mm)	ring-Ø (mm)	box quantity
40411	125	78	5.	16	80	2 *
	135	78	5.1/4	16	80	2 *
	145	78	5.3/4	16	80	2 *

**DUO D-Ring** (Info page 44)  
flexible plastic mouthpiece  
reinforced with a stainless steel cable

This bit can be used on both sides, either as a straight bar or with a low port that leaves space for the tongue.

article no.	size (mm)	qualities available	size (inch)	thickness (mm)	ring-Ø (mm)	box quantity
40419	120	00	4.3/4	16	80	2 *
	130	00	5.1/8	16	80	2 *
	140	00	5.1/2	16	80	2 *



**D-Ring, single jointed**  
stainless steel



article no.	size (mm)	qualities available	size (inch)	thickness (mm)	ring-Ø (mm)	box quantity
40915	125	56	5.	16	80	2 *
	135	56	5.1/4	16	80	2 *
	145	56	5.3/4	16	80	2 *



**D-Ring, double jointed**  
stainless steel



article no.	size (mm)	qualities available	size (inch)	thickness (mm)	ring-Ø (mm)	box quantity
40916	125	56	5.	16	80	2 *
	135	56	5.1/4	16	80	2 *
	145	56	5.3/4	16	80	2 *



**D-Ring, single jointed**  
Copper coated rollers  
D-Rings stainless steel

article no.	size (mm)	qualities available	size (inch)	thickness (mm)	ring-Ø (mm)	box quantity
40155	125	00	5.	13	60	2
	135	00	5.1/4	13	60	2
	145	00	5.3/4	13	60	2



Pelhams can be used with one or two reins, which enables different rein options. Direct pressure is applied to the horse's tongue and bars if the rider only uses the snaffle rein. If horses tend to toss the head it makes sense to attach a second rein to the lower cheek piece ring to apply pressure on the horse's poll. The horse will try to dodge this pressure by lowering the head. The curb chain should come into play at maximum angle of 45° (lower cheek to horse's mouth) to avoid the horse lowering its head too much.



**Dynamic RS short shank Pelham, double jointed**  **SENSOGAN®** **AURIGAN®**

Brilliant for sensitive horses being ridden in a Pelham. The mouthpiece perfectly follows the anatomy of the mouth to improve the horse's willingness and cooperation. The rein aids come into play earlier due to the lever action of the short cheeks. The best choice for strong but sensitive horses as the ergonomically formed mouthpiece enables an even distribution of gentle pressure onto the tongue.

article no.	size (mm)	qualities available		size (inch)	thickness (mm)	cheek (cm)	lower cheeks (cm)	box quantity
42014	115	78	88	4.1/2	16	10	4,5	2 *
	125	78		5.	16	10	4,5	2 *
	135	78		5.1/4	16	10	4,5	2 *
	145	78	88	5.3/4	16	10	4,5	2 *
	155	78	88	6.1/8	16	10	4,5	2 *



**TURNADO short shank Pelham, single jointed**  **AURIGAN®**

A soft Pelham as the mouthpiece is a better fit for the horse's anatomy in contrast to conventional single jointed bits. The horse's willingness to cooperate is optimised and the rein aids come into play earlier due to the short cheeks. A good choice for strong horses that can be unresponsive to the signals of double jointed bits.

article no.	size (mm)	qualities available		size (inch)	thickness (mm)	cheek (cm)	lower cheeks (cm)	box quantity
42087	125		88	5.	16	10	4,5	2
	135		88	5.1/4	16	10	4,5	2
	145		88	5.3/4	16	10	4,5	2



**Comfort Mouth (CM) short shank Pelham** 

Comfort mouth – the name speaks for itself. The mouthpiece provides the horse with ultimate comfort and makes it accepting the rider's hand. The port offers broad space for long and fleshy tongues. The bit helps to prevent tongue vices in an ideal way.

article no.	size (mm)	qualities available		size (inch)	thickness (mm)	cheek (cm)	lower cheeks (cm)	box quantity
42020	115		88	4.1/2	16	10	4,5	2
	125		88	5.	16	10	4,5	2
	135		88	5.1/4	16	10	4,5	2
	145		88	5.3/4	16	10	4,5	2



**Short shank Pelham, double jointed, stainless steel** 

article no.	size (mm)	qualities available		size (inch)	thickness (mm)	cheek (cm)	lower cheeks (cm)	box quantity
42126	115	56		4.1/2	16	10	4,5	2
	125	56		5.	16	10	4,5	2
	135	56		5.1/4	16	10	4,5	2
	145	56		5.3/4	16	10	4,5	2
	155	56		6.1/8	16	10	4,5	2

**Short shank Pelham, single jointed, stainless steel**



article no.	size (mm)	qualities available	size (inch)	thickness (mm)	cheek (cm)	lower cheeks (cm)	box quantity
42125	115	56	4.1/2	16	10	4,5	2 *
	125	56	5.	16	10	4,5	2 *
	135	56	5.1/4	16	10	4,5	2 *
	145	56	5.3/4	16	10	4,5	2 *



**Pelham, single jointed, stainless steel**



article no.	size (mm)	qualities available	size (inch)	thickness (mm)	cheek (cm)	lower cheeks (cm)	box quantity
42101	125	56	5.	16	14	7	2
	135	56	5.1/4	16	14	7	2
	145	56	5.3/4	16	14	7	2



**Pelham curved Mullen Mouthpiece, stainless steel**



article no.	size (mm)	qualities available	size (inch)	thickness (mm)	cheek (cm)	lower cheeks (cm)	box quantity
42094	125	56	5.	12	14	7	2
	135	56	5.1/4	12	14	7	2
	145	56	5.3/4	12	14	7	2



**Pelham bit converters (by pair)**  
with HS Logo on the leather part

article no.	size (mm)	qualities available	colour	box quantity
<b>perlon black – length: 30 cm</b>				
49189	030	00	black	10 *
<b>Leather with nylon rope round webbed – length: 16 cm</b>				
42112	000	00	black	5 *
	001	00	dark brown	5 *



**Curb chain guard rubber black optimum fit**

article no.	size (mm)	qualities available	box quantity
45249	000	71	10 *



**Curb chain guard rubber black**

article no.	size (mm)	qualities available	box quantity
45250	060	71	25 *







**KK Universal**



This 3-Ring bit enables 4 different ways of attaching the reins to the bit. It is therefore very versatile and extremely popular among Jumpers as it offers the opportunity to achieve more control when needed. Highly recommended for swift downward transitions and for control and quick change of direction in the speed classes. Turns can also be ridden with ease as this bit offers more control than a standard loose ring snaffle. Same mouthpiece as 40511.

article no.	size (mm)	qualities available		size (inch)	thickness (mm)	ring-Ø (mm)	box quantity
40510	125	78		5.	18	70	2 *
	135	78		5.1/4	18	70	2 *
	145	78		5.3/4	18	70	2 *
42111	000	00		black / length: 59 cm			5



**KK ULTRA Universal**



This bit is also extremely versatile due to the different rein options. It is a good choice for sensitive horses as it is a little bit softer than model 40607, leading to a higher level of acceptance. The lever action has a slight delay due to the lateral offset position of the upper ring. Riders can additionally add a curb strap to get more direct action. The pressure on the poll is limited that way.

article no.	size (mm)	qualities available		size (inch)	thickness (mm)	ring-Ø (mm)	box quantity
40618	115	78	88	4.1/2	16	70	2 *
	125	78	88	5.	16	70	2 *
	135	78	88	5.1/4	16	70	2 *
	145	78	88	5.3/4	16	70	2 *
40608	120	78		4.3/4	18	70	2 *
	130	78		5.1/8	18	70	2 *
	140	78		5.1/2	18	70	2 *
42111	000	00		black / length: 59 cm			5



**Dynamic RS Universal double jointed**



This bit is extremely versatile due to the different rein options. In addition the ergonomically formed mouthpiece allows a rapid and balanced effect on the tongue. The lever action has a slight delay due to the lateral offset position of the upper ring. Riders can additionally add a curb strap to get more direct action. The pressure on the poll is limited that way.

article no.	size (mm)	qualities available		size (inch)	thickness (mm)	ring-Ø (mm)	box quantity
40626	125	78		5.	16	70	2 *
	135	78		5.1/4	16	70	2 *
	145	78		5.3/4	16	70	2 *
42111	000	00		black / length: 59 cm			5

**Different rein options for Universal bits**

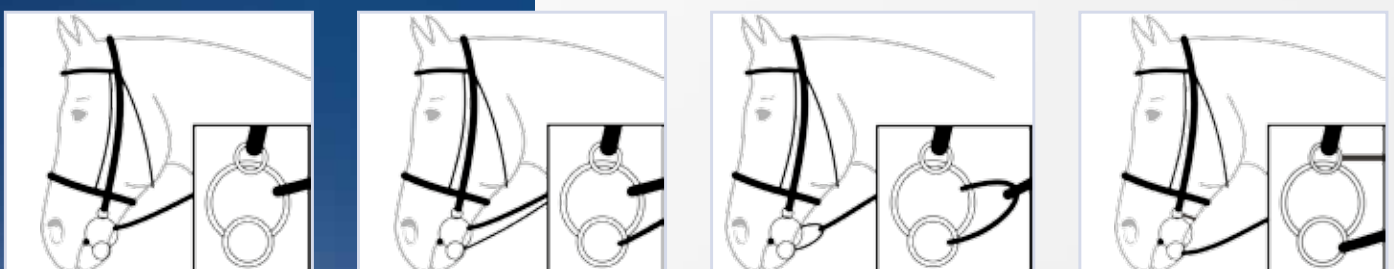

**KK ULTRA Vienna**



This 3-Ring bit enables 4 different ways of attaching the reins to the bit (see p.42). It is therefore very versatile and extremely popular among Jumpers as it can achieve more control when needed without being too sharp. Depending on the way the reins are being attached to the rings varying degrees of lever action intensify the rider's aids.

article no.	size (mm)	qualities available			size (inch)	thickness (mm)	ring-Ø (mm)	box quantity
40607	120	78			4.3/4	18	70	2 *
	130	78			5.1/8	18	70	2 *
	140	78			5.1/2	18	70	2 *



**3-Ring bit "Vienna", stainless steel single jointed**



article no.	size (mm)	qualities available			size (inch)	thickness (mm)	ring-Ø (mm)	box quantity
41309	115	56			4.1/2	18	65	2
	125	56			5.	18	70	2
	135	56			5.1/4	18	70	2
	145	56			5.3/4	18	70	2

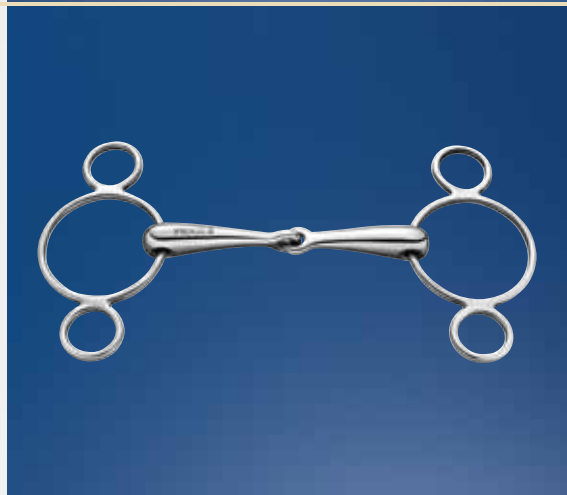

**Kimblewick, stainless steel**



Works in a similar way to a Pelham. It can be ridden with two reins and the use of a curb chain puts additional pressure on the horse's poll. However, the lever action is considerably low due to the shorter D-Ring shaped cheeks, resulting in less pressure.

article no.	size (mm)	qualities available			size (inch)	thickness (mm)	box quantity
42309	115	56			4.1/2	16	2
	125	56			5.	16	2
	135	56			5.1/4	16	2



**KK ULTRA Kimblewick**



Works in a similar way to a Pelham. It can be ridden with two reins and the use of a curb chain puts additional pressure on the horse's poll. However, the lever action is considerably low due to the shorter D-Ring shaped cheeks, resulting in less pressure.

article no.	size (mm)	qualities available			size (inch)	thickness (mm)	box quantity
42311	125	78	88		5.	16	2 *
	135	78			5.1/4	16	2 *
	145	78	88		5.3/4	16	2 *



SPRENGER Duo bits are very gentle on the horse's mouth. The mouthpiece is made of soft, flexible plastic which adapts to the horse's mouth in an ideal way. The material is food-safe, solvent-free and does not contain any plasticisers. The mouthpiece is reinforced with a steel cable to make it stable and to provide more security. Different from pure metal bits there is the danger of the plastic being easily bitten through when the bit is not attached correctly and gets into contact with the teeth. No returns or exchanges are possible if there are chew marks on the mouthpiece.

Dual application for item no. 40419 + 40801 + 41302

1. straight edged flexible bar
2. reversed leaves space for the tongue

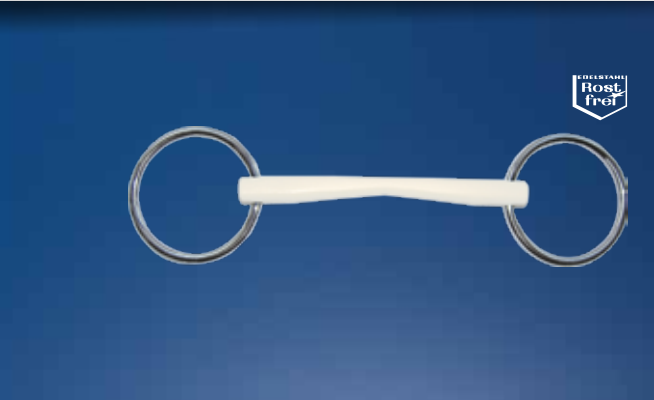

Duo Loose Ring

article no.	size (mm)	qualities available	size (inch)	thickness (mm)	ring-Ø (mm)	box quantity
40801	115	00	4.1/2	16	55	5 *
	125	00	5.	16	70	5 *
	135	00	5.1/4	16	70	5 *
	145	00	5.3/4	16	70	5 *

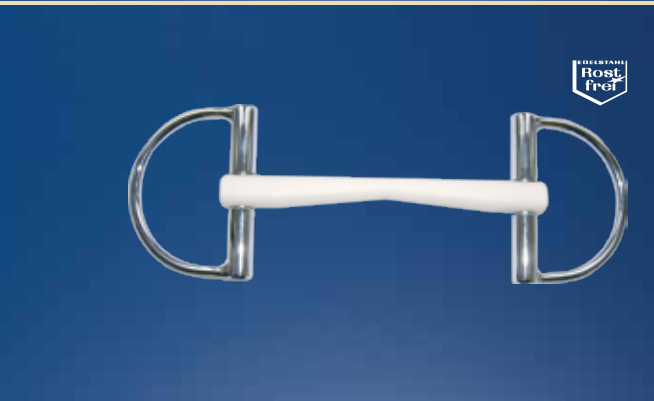

Duo D-Ring

article no.	size (mm)	qualities available	size (inch)	thickness (mm)	ring-Ø (mm)	box quantity
40419	120	00	4.3/4	16	80	2 *
	130	00	5.1/8	16	80	2 *
	140	00	5.1/2	16	80	2 *

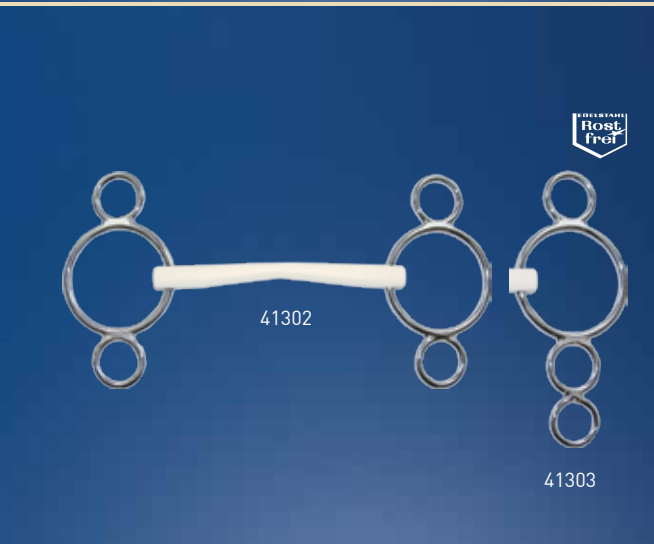

Duo 3-Ring "Vienna"

article no.	size (mm)	qualities available	size (inch)	thickness (mm)	ring-Ø (mm)	box quantity
41302	125	00	5.	16	70	2
	135	00	5.1/4	16	70	2
	145	00	5.3/4	16	70	2

Duo Show Jumping bit "Vienna"  
side parts 2 rings bottom

article no.	size (mm)	qualities available	size (inch)	thickness (mm)	ring-Ø (mm)	box quantity
41303	125	00	5.	16	70	2 *
	135	00	5.1/4	16	70	2 *
	145	00	5.3/4	16	70	2 *

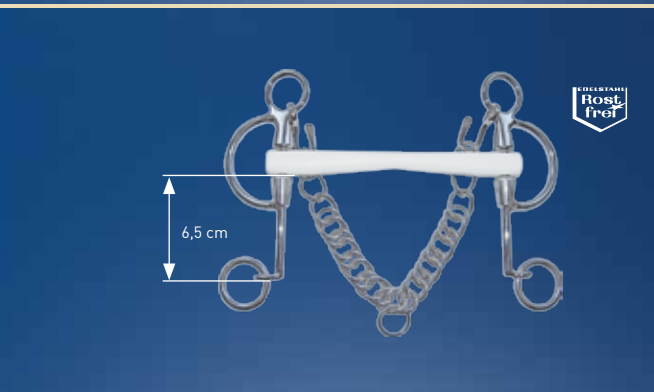

Duo Pelham

article no.	size (mm)	qualities available	size (inch)	thickness (mm)	cheek (cm)	lower cheeks (cm)	box quantity
42001	120	00	4.3/4	16	13,5	6,5	2
	130	00	5.1/8	16	13,5	6,5	2
	140	00	5.1/2	16	13,5	6,5	2

Rubber bits from SPRENGER are made of soft but tough rubber that has a Stainless steel cable inside to reinforce the mouthpiece. Rubber generally has an “eraser-effect”. It is therefore important that horses are salivating and chewing well when using these bits. If the horse does not produce enough saliva the rubber bit will be uncomfortable.

Different from pure metal bits there is the danger of the rubber being easily bitten through when the bit is not attached correctly and gets into contact with the teeth. No returns or exchanges are possible if there are chew marks on the mouthpiece.

**Rubber bit, single jointed**  
soft but tough rubber

article no.	size (mm)	qualities available	size (inch)	thickness (mm)	ring-Ø (mm)	box quantity
40833	125	56	5.	18	70	5
	135	56	5.1/4	18	70	5
	145	56	5.3/4	18	70	5



**Rubber Mullen Mouth bit**  
soft but tough rubber, flexible  
reinforced with a stainless steel cable

article no.	size (mm)	qualities available	size (inch)	thickness (mm)	ring-Ø (mm)	box quantity
40842	125	55	5.	20	70	5
	135	55	5.1/4	20	70	5
	145	55	5.3/4	20	70	5



**Rubber Pelham, single jointed**  
soft but tough rubber

article no.	size (mm)	qualities available	size (inch)	thickness (mm)	cheek (cm)	lower cheeks (cm)	box quantity
42104	135	56	5.1/4	18	14	7	2
	145	56	5.3/4	18	14	7	2



**Rubber Mullen Mouth**  
flexible

article no.	size (mm)	qualities available	size (inch)	thickness (mm)	cheek (cm)	lower cheeks (cm)	box quantity
<b>reinforced with a stainless steel cable</b>							
42108	135	56	5.1/4	18	14	7	2

**Rubber Mullen Mouth Pelham**  
vulcanic rubber mouthpiece, rigid

article no.	size (mm)	qualities available	size (inch)	thickness (mm)	cheek (cm)	lower cheeks (cm)	box quantity
<b>Metal core</b>							
42109	125	56	5.	18	14	7	2
	135	56	5.1/4	18	14	7	2
	145	56	5.3/4	18	14	7	2







**KK ULTRA Full Cheek**

This bit lies quietly in the horse's mouth as the cheeks prevent the bit from being pulled through and therefore avoids inconvenient pressure on the back teeth. The double jointed mouthpiece with the 45° angle remains in the correct central position of the tongue ensuring the rein aids work perfectly in the horse's mouth. The cheeks are most helpful with turning aids especially with young horses. The gentle pressure against the face on the outside of the turn supports the rider's aid making turns much easier for the horse to understand and for the rider to carry out. The upper part of the cheeks are curved outwards away from the horse to avoid uncomfortable pressure on the jaws.



article no.	size (mm)	qualities available		size (inch)	thickness (mm)	ring-Ø (mm)	box quantity
41606	120	78	88	4.3/4	18	50	2 *
	130	78		5.1/8	18	50	2 *
	140		88	5.1/2	18	50	2 *



**Dynamic RS Full Cheek**

This bit lies very quietly in the horse's mouth as the cheeks prevent the bit from being pulled through the mouth. It avoids inconvenient pressure on the back teeth. The mouthpiece remains in the correct central position letting the rein aids work perfectly with the horse's mouth. The cheeks are most helpful with turning aids especially with young horses. The gentle pressure against the face on the outside of the turn supports the rider's aid making turns much easier for the horse to understand and for the rider to carry out. The upper part of the cheeks are curved outwards away from the horse to avoid uncomfortable pressure on the jaws.



article no.	size (mm)	qualities available		size (inch)	thickness (mm)	ring-Ø (mm)	box quantity
41414	125	78		5.	16	50	2 *
	135	78		5.1/4	16	50	2 *
	145	78		5.3/4	16	50	2 *



**Full Cheek, stainless steel**

This bit lies quietly in the horse's mouth as the cheeks prevent the bit from being pulled through the mouth. It avoids inconvenient pressure on the back teeth.



article no.	size (mm)	qualities available		size (inch)	thickness (mm)	ring-Ø (mm)	box quantity
41906	115	56		4.1/2	14	50	2 *
	125	56		5.	16	50	2 *
	135	56		5.1/4	16	50	2 *
	145	56		5.3/4	16	50	2 *



**Full Cheek, stainless steel coated copper roller**



article no.	size (mm)	qualities available		size (inch)	thickness (mm)	ring-Ø (mm)	box quantity
41256	125	56		5.	14	45	2
	135	56		5.1/4	14	45	2
	145	56		5.3/4	14	45	2

**Dynamic RS Full cheek**



This bit lies very quietly in the horse's mouth as the cheeks prevent the bit from being pulled through the mouth. It avoids inconvenient pressure on the back teeth. The mouthpiece remains in the correct central position letting the rein aids work perfectly with the horse's mouth. Brilliant for horses that are overactive in the mouth playing too much with the lozenge and therefore unresponsive to the signals of double jointed bits. The cheeks are most helpful with turning aids especially with young horses. The gentle lateral contact supports the rider's aid making turns much easier for the horse to understand and for the rider to carry out. The upper part of the cheeks are curved outwards away from the horse to avoid uncomfortable pressure on the jaws.

article no.	size (mm)	qualities available		size (inch)	thickness (mm)	ring-Ø (mm)	box quantity
41422	115		88	4.1/2	16	50	2 *
	125		78 88	5.	16	50	2 *
	135		78 88	5.1/4	16	50	2 *
	145		88	5.3/4	16	50	2 *



**TURNADO Full Cheek Gag**



This bit is the favourite choice for show jumpers, as the control with this bit enables challenging courses to be jumped with ease. The TURNADO mouthpiece enables precise rein aids especially as the directional control is reinforced by the full cheeks. The use of the second rein in combination with a cheek piece for gag bits enables the rider to increase the pressure on the horse's poll. Highly recommended to cope with the most technical challenges in any show jumping course. The upper part of the cheeks are curved outwards away from the horse to avoid uncomfortable pressure on the jaws.

article no.	size (mm)	qualities available		size (inch)	thickness (mm)	ring-Ø (mm)	box quantity
41588	125		78	5.	18	60	1 *
	135		78 88	5.1/4	18	60	1 *
	145		78	5.3/4	18	60	1 *



**Gag cheeks (by pair)**, Leather with nylon rope round webbed

42115	000	00			black / length: 45 cm	1 *
	001	00			dark brown / length: 45 cm	1 *



**TURNADO Full Cheek, stainless steel**



This bit lies quietly in the horse's mouth as the cheeks prevent the bit from being pulled through the mouth. It avoids inconvenient pressure on the back teeth. The gentle lateral contact of the cheeks supports the rider's aid making turns easier for the horse to understand and for the rider to carry out.

The mouthpiece is turned forward by 45° therefore the rein aids reach the horse's mouth precisely with an evenly distributed smooth pressure on the entire tongue.

article no.	size (mm)	qualities available		size (inch)	thickness (mm)	ring-Ø (mm)	box quantity
41587	115	56		4.1/2	16	50	2
	125	56		5.	16	50	2
	135	56		5.1/4	16	50	2
	145	56		5.3/4	16	50	2
	155	56		6.1/8	16	50	2



The MAX-Control is a double jointed bit which, at a first glance, cannot be distinguished from other double jointed loose ring snaffles. However, it is a correction or training bit which locks at a certain angle and thus becomes a straight bar.

The bit lies very well in the mouth when the horse is working properly. When the horse opposes the rider's hand the more intensive rigid effect occurs.

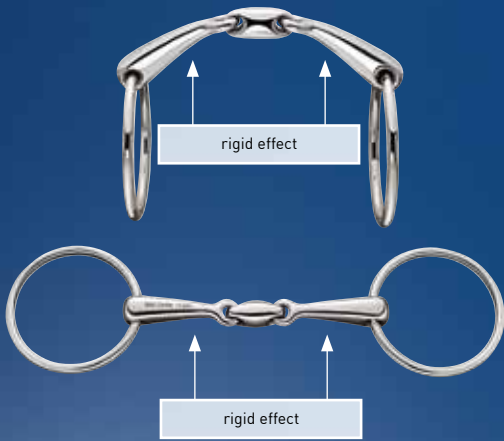

**MAX-Control**



article no.	size (mm)	qualities available			size (inch)	thickness (mm)	ring-Ø (mm)	box quantity
40710	115	56			4.1/2	14	55	5 *
	125	56			5.	16	70	5 *
	135	56			5.1/4	16	70	5 *
	145	56			5.3/4	16	70	5 *
	155	56			6.1/8	16	70	5 *

**MAX-Control bradoon**



article no.	size (mm)	qualities available			size (inch)	thickness (mm)	ring-Ø (mm)	box quantity
40711	125	56			5.	12	55	2 *
	135	56			5.1/4	12	55	2 *
	145	56			5.3/4	12	55	2 *

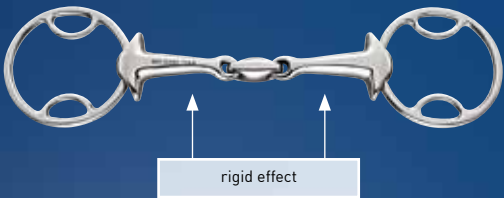

**MAX-Control 3-TYPE bit**



article no.	size (mm)	qualities available			size (inch)	thickness (mm)	ring-Ø (mm)	box quantity
40713	125	56			5.	16	70	5 *
	135	56			5.1/4	16	70	5 *
	145	56			5.3/4	16	70	5 *

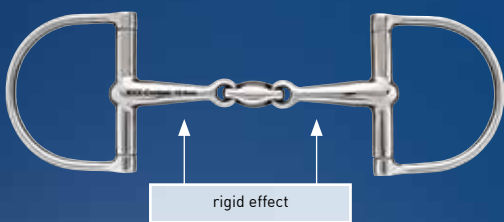

**MAX-Control D-Ring**



article no.	size (mm)	qualities available			size (inch)	thickness (mm)	ring-Ø (mm)	box quantity
40717	125	56			5.	16	80	5 *
	135	56			5.1/4	16	80	5 *
	145	56			5.3/4	16	80	5 *

MAX-Control Full Cheek



article no.	size (mm)	qualities available	size (inch)	thickness (mm)	cheek (cm)	box quantity
40716	125	56	5.	16	16	5 *
	135	56	5.1/4	16	16	5 *
	145	56	5.3/4	16	16	5 *

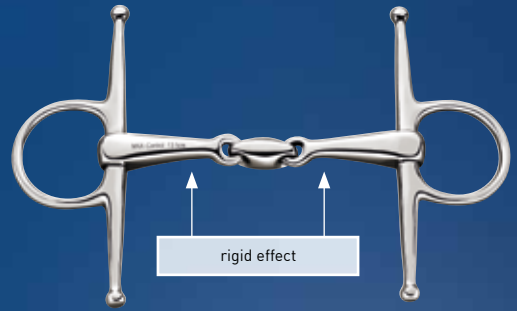

MAX-Control short shank Pelham



article no.	size (mm)	qualities available	size (inch)	thickness (mm)	cheek (cm)	lower cheeks (cm)	box quantity
42700	125	56	5.	16	10	5	5
	135	56	5.1/4	16	10	5	5
	145	56	5.3/4	16	10	5	5



MAX-Control Butterfly Liverpool bit



article no.	size (mm)	qualities available	size (inch)	thickness (mm)	box quantity
43192	125	56	5.	16	2
	155	56	6.1/8	16	2





The most common bitless bridle, which is often used when horses have an injury in the mouth area or evade the rein aids. A hackamore acts on the poll, the sensitive bridge of the nose and the chin dimple. Single sided rein aids are not possible as the hackamore would catch an edge. The rider should be able to ride the horse with weight and shank aids through the turns when using a hackamore.



**Hackamore with curb chain and st.st. cheeks**  
noseband, rubber covered chain – length: 31 cm



article no.	qualities available			box quantity
42141	000		56	2

**Hackamore with curb chain and st.st. cheeks**  
noseband, braided leather covered chain – length: 35 cm



article no.	qualities available			box quantity
42143	000		56	2



**Hackamore**



article no.	qualities available			box quantity
-------------	---------------------	--	--	--------------

**Hackamore with leather curb strap**  
noseband, leather – length: 21,5 cm

42144	000		55	black	5 *
	001		55	brown	5 *

**Pony-Hackamore with leather curb strap**  
noseband, leather – length: 19 cm

42145	000		55	black	5
-------	-----	--	----	-------	---

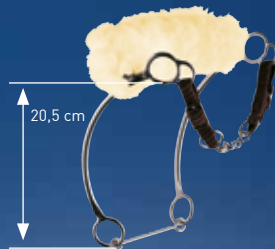

**Kombi-Hackamore "SPRENGER"**  
with noseband, covered with lambswool – length: 30 cm



The Kombi-Hackamore offers the opportunity to attach an additional snaffle to intensify the effect of the hackamore. Acts on nose, poll and lower jaw.

article no.	qualities available			box quantity
42146	000		55	2 *



**Kombi-Hackamore**  
with noseband, covered with lambswool – length: 30 cm



The Kombi-Hackamore offers the opportunity to attach an additional snaffle to intensify the effect of the hackamore. Only acts on nose and lower jaw, no poll pressure.

article no.	qualities available			box quantity
42147	000		55	2



**Accessories**

article no.	qualities available			box quantity
-------------	---------------------	--	--	--------------

**Noseband, lambswool to 42146 + 42147**

42146	001	00		1 *
-------	-----	----	--	-----

**Curb chain for Hackamore**

45054	000		02	5
-------	-----	--	----	---

**MULTI JOINT**

SENSOGAN®

The mouthpiece of the Sprenger MULTI JOINT bit is made of multiple joints that are connected to each other. This makes the bit very flexible and suitable for horses that try to get away from the riders aids by pushing against or leaning on the bit. The bit enables an effective influence onto the tongue and gives riders of strong and keen horses better control.

article no.	size (mm)	qualities available			size (inch)	thickness (mm)	ring-Ø (mm)	box quantity
40525	135			78	5.1/4	16	70	1 *



**French link bradoon**

AURIGAN

The French link is a double jointed bit with a flat, tapered lozenge. When using the rein aids the whole surface of the mouthpiece lies on the tongue and creates a "spotted" pressure. It operates on the tongue with its flat edge.

article no.	size (mm)	qualities available			size (inch)	thickness (mm)	ring-Ø (mm)	box quantity
40205	140			89	5.1/2	14	55	2
	150			89	6.	14	55	2



**French link**



article no.	size (mm)	qualities available			size (inch)	thickness (mm)	ring-Ø (mm)	box quantity
41110	115	56			4.1/2	16	65	5
	125	56			5.	16	65	5
	135	56			5.1/4	16	65	5
	145	56			5.3/4	16	65	5



**Spoon Mouth snaffle**

AURIGAN

Bit with integrated spoon mouth snaffle for short term correction of tongue problems.

article no.	size (mm)	qualities available			size (inch)	thickness (mm)	ring-Ø (mm)	box quantity
40032	135			88	5.1/4	22	70	2



**Rubber bit port black**

The rubber bit port is adaptable to single jointed bits. It prevents horses from pulling back the tongue.

article no.	size (mm)	qualities available			box quantity
40021	000			71	10



**Linda Tellington-Jones bit stainless steel with copper roller**



article no.	size (mm)	qualities available			size (inch)	thickness (mm)	box quantity
41016	125	56			5.	13	5
	135	56			5.1/4	13	5
	145	56			5.3/4	13	5



# Double bridles:

The double bridle consists of a Weymouth and a bradoon. The bradoon should be equal in size and shape to the standard snaffle currently used, and lies at the same place in the horse's mouth. The Weymouth is attached a little bit lower where the horse's head gets thinner. Therefore, you need to choose a Weymouth that is ½ to 1 cm smaller than the bradoon.

It is important that the cheeks of the Weymouth fit closely to both sides of the horse's mouth. If there is too much space between the corners of the mouth and the cheek pieces the bit will slide across the bars making it uncomfortable, or even worse the bit might tilt. The correct size and position in the horse's mouth becomes even more important when using specially designed mouthpieces (e.g. the Bemelmans Weymouth or KK Dressage bit).

When attaching the curb chain the rider should be able to pull/move the Weymouth up to an angle of 45°.

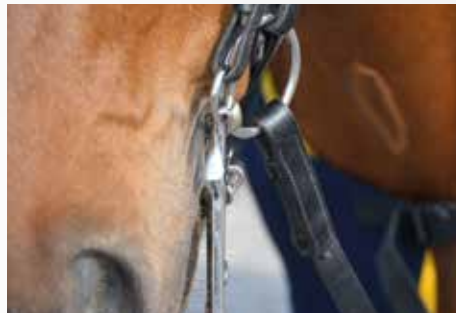

The Weymouth affects different parts of the horse's head: The jaw through the tongue, the poll by leverage and the lower jaw bone through the curb chain. The potential effectiveness of the influence on the poll depends on the length of the upper and lower cheek parts. The most popular lower cheek size is 7 cm. Weymouth bits with 5 cm lower cheeks are often called "Baby Weymouth bits". This expression might imply that it is made for beginners but it is not. The rider's aids and their effect are more direct and quicker due to the short cheeks. Nevertheless, the pressure on both lower jaw bones and poll is less effective with shorter cheeks due to the different leverage.

The space in the horse's mouth is limited. Especially the palate which is flatter than we previously expected. When using a Weymouth with a high port there can be pressure on the sensitive palate when pulling the reins. We highly recommend choosing a Weymouth that offers space for the tongue without squeezing the palate.



**Charlotte Dujardin**

"With decades of experience and commitment to design and research, I choose Sprenger with confidence for my horses so they can perform at their very best."



**Carl Hester**

"The horse's mouth is to be respected and Sprenger bits use only the finest metals and craftsmanship – giving me total reassurance. Your horse only has one mouth – so make sure you use the best bits available: Sprenger."









**Bemelmans Weymouth**

The optimum fit of the Bemelmans Weymouth keeps the horse on the bit. It has a smooth, rounded port and the shape of the mouthpiece is adapted to the sensitive palatal arch. The thickness is tapered towards the center. The acceptance of this bit results in soft and even distribution of pressure across the entire tongue due to the exceptional form of the mouthpiece. The horse's impulse to put the tongue over the bit is nearly neutralised. A Weymouth that meets with highest requirements, resulting in relaxed and contented horses.



Jean Bemelmans

During his active career **Jean Bemelmans** won around 50 international dressage Grand Prix. For more than 20 years he has been coaching and led the Spanish dressage team to 7 medals at the European and World Championships and the Olympic Games. He is currently working as the national coach of the French dressage team.

**Bemelmans Weymouth**  
lower cheeks 7 cm

SENSOGAN®  
AURIGAN

This mouthpiece has a smooth, rounded port and the shape of the mouthpiece is adapted to the sensitive palatal arch. The acceptance of this bit results in soft and even distribution of pressure across the entire tongue. The horse's impulse to put the tongue over the bit is nearly neutralised.



article no.	size (mm)	qualities available			size (inch)	thickness (mm)	cheek (cm)	lower cheeks (cm)	box quantity
42219	125	78			5.	14	13	7	2 *
	135	78			5.1/4	14	13	7	2 *
	145	78			5.3/4	14	13	7	2 *
42220	115	78	88		4.1/2	16	13	7	2
	125	78	88		5.	16	13	7	2 *
	135	78	88		5.1/4	16	13	7	2 *
	145	78	88		5.3/4	16	13	7	2 *

**Bemelmans Weymouth**  
lower cheeks 5 cm

SENSOGAN®  
AURIGAN

Offers the same advantages as model 42220. Less rein action needed as it is more direct due to the short cheeks. Sensitive rider hands are therefore very important.



article no.	size (mm)	qualities available			size (inch)	thickness (mm)	cheek (cm)	lower cheeks (cm)	box quantity
42119	125	78			5.	14	11	5	2 *
	135	78			5.1/4	14	11	5	2 *
	145	78			5.3/4	14	11	5	2 *
42120	115	78	88		4.1/2	16	11	5	2 *
	125	78	88		5.	16	11	5	2 *
	135	78	88		5.1/4	16	11	5	2 *
	145	78	88		5.3/4	16	11	5	2 *

**HO-Weymouth**  
lower cheeks 7 cm

SENSOGAN®  
AURIGAN™

This unique Weymouth with its slanting mouthpiece and a smooth, rounded port is angled forward and enables fine distribution of pressure on the tongue. The bit takes advantage of the exceptional sensitivity of the tongue ensuring precise rein aids. Suitable for horses that dislike tongue pressure. Brilliant for introducing a horse gently to a Weymouth bit. The slanting mouthpiece encourages the harmony between the rider's hand and the horse's mouth providing a relaxed and secure contact to the Weymouth.

article no.	size (mm)	qualities available			size (inch)	thickness (mm)	cheek (cm)	lower cheeks (cm)	box quantity
42272	125	78			5.	12	13	7	2*
	135	78			5.1/4	12	13	7	2*
	145	78			5.3/4	12	13	7	2*
42273	125	78	88		5.	14	13	7	2*
	135	78	88		5.1/4	14	13	7	2*
	145	78	88		5.3/4	14	13	7	2*
42274	125	78	88		5.	16	13	7	2*
	135	78	88		5.1/4	16	13	7	2*
	145	78	88		5.3/4	16	13	7	2*



**HO-Weymouth**  
lower cheeks 5 cm

SENSOGAN®  
AURIGAN™

Offers the same advantages as model 42274, but it exerts less pressure on the horse's neck. Less rein action needed as it is more direct due to the short cheeks. Sensitive rider hands are therefore important.

article no.	size (mm)	qualities available			size (inch)	thickness (mm)	cheek (cm)	lower cheeks (cm)	box quantity
42172	125	78			5.	12	11	5	2*
	135	78			5.1/4	12	11	5	2*
	145	78			5.3/4	12	11	5	2*
42173	115	78	88		4.1/2	14	11	5	2
	125	78	88		5.	14	11	5	2*
	135	78	88		5.1/4	14	11	5	2*
	145	78	88		5.3/4	14	11	5	2*
42174	115	78	88		4.1/2	16	11	5	2*
	125	78	88		5.	16	11	5	2*
	135	78	88		5.1/4	16	11	5	2*
	145	78	88		5.3/4	16	11	5	2*



**Special Dressage bit**  
lower cheeks 7 cm

SENSOGAN®  
AURIGAN™

The ergonomically shaped port of this Weymouth offers broad space for the tongue and is angled forward by 30°. Particularly comfortable for horses that are irritated by a cramped tongue as the bit reduces the pressure on the sensitive borders of the tongue. The horse's motivation is enormously increased and the rider benefits from a better contact.

article no.	size (mm)	qualities available			size (inch)	thickness (mm)	cheek (cm)	lower cheeks (cm)	box quantity	
42262	125	78	79	88	89	5.	16	13	7	2*
	135	78	79			5.1/4	16	13	7	2*
	145	78	79	88	89	5.3/4	16	13	7	2*



42262 ... 78

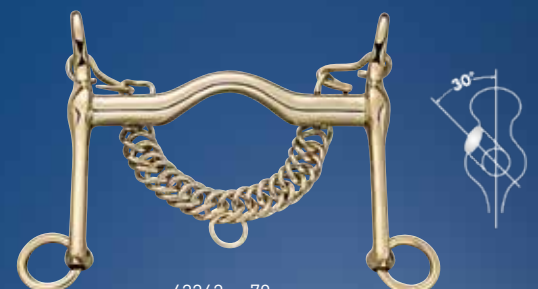

42262 ... 79

**Hubertus Schmidt Weymouth bits with fixed curb hooks**

A Weymouth with fixed curb chain hooks prevents the cheeks from being pinched. Maintains even pressure of the curb chain which has only slight clearance. A good choice for riders who are inexperienced in riding in a double bridle.

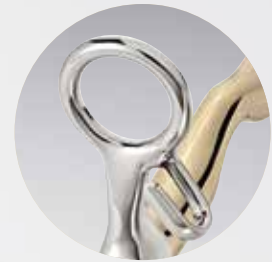

Hubertus Schmidt

**Hubertus Schmidt**, Olympic Gold Medal and World-Cup winner and 5 times German National Champion, is one of the most successful German dressage trainers. In his earlier years he was also very successful in show jumping competitions up to the highest national level. Today, he lives in Altenautal, Westphalia and manages a training and breeding stable he took over from his father.

**Weymouth with fixed curb hooks with a high port**

SENSOGAN®

By taking the reins the rider can change the angle of the Weymouth to apply pressure on the palate with the high port. The Weymouth can therefore only be recommended for experienced and precise rider hands and is suitable for strong horses that are not sensitive and have a normal or high palatal arch.



42247 1.. 78  
7 cm

42247 9.. 78  
5 cm

article no.	size (mm)	qualities available	size (inch)	thickness (mm)	cheek (cm)	lower cheeks (cm)	box quantity
42247	125	78	5.	16	13	7	2
	135	78	5.1/4	16	13	7	2
	145	78	5.3/4	16	13	7	2
42247	925	78	5.	16	11	5	2
	935	78	5.1/4	16	11	5	2
	945	78	5.3/4	16	11	5	2

**Weymouth with fixed curb hooks with a slight port**

SENSOGAN®

The smooth roundings of the mouthpiece avoid harsh pressure in the horse's mouth. Brilliant for horses with a flat palatal arch. Sensitive horses get more relaxed as the curb chain has only slight clearance. A good choice for riders who are inexperienced in riding in a double bridle.



42248 1.. 78  
7 cm

42248 9.. 78  
5 cm

article no.	size (mm)	qualities available	size (inch)	thickness (mm)	cheek (cm)	lower cheeks (cm)	box quantity
42248	125	78	5.	16	13	7	2 *
	135	78	5.1/4	16	13	7	2 *
	145	78	5.3/4	16	13	7	2 *
42248	925	78	5.	16	11	5	2 *
	935	78	5.1/4	16	11	5	2 *
	945	78	5.3/4	16	11	5	2 *

**HS Weymouth with flexible hooks and with a high port**

SENSOGAN®  
AURIGAN

By taking the reins the rider can change the angle of the Weymouth to apply pressure on the palate with the high port. The Weymouth can therefore only be recommended for experienced and precise rider hands and is suitable for strong horses that are not sensitive and have a normal or high palatal arch.

article no.	size (mm)	qualities available		size (inch)	thickness (mm)	cheek (cm)	lower cheeks (cm)	box quantity
42268	125	78	88	5.	16	13	7	2 *
	135	78	88	5.1/4	16	13	7	2 *
	145	78	88	5.3/4	16	13	7	2 *
42168	125	78	88	5.	16	11	5	2 *
	135	78	88	5.1/4	16	11	5	2 *
	145	78	88	5.3/4	16	11	5	2 *



42268  
7 cm

42168  
5 cm

**HS Weymouth with flexible hooks and with a slight port**

SENSOGAN®  
AURIGAN

Weymouth with a slight port that offers space for the tongue without squeezing the sensitive palate. The mouthpiece curves around the tongue in a smooth bow. A good choice for horses that have issues with the contact.

article no.	size (mm)	qualities available		size (inch)	thickness (mm)	cheek (cm)	lower cheeks (cm)	box quantity
42278	125	78	88	5.	16	13	7	2 *
	135	78	88	5.1/4	16	13	7	2 *
	145	78	88	5.3/4	16	13	7	2 *
42178	125	78	88	5.	16	11	5	2 *
	135	78	88	5.1/4	16	11	5	2 *
	145	78	88	5.3/4	16	11	5	2 *



42278  
7 cm

42178  
5 cm

**HS Weymouth with flexible hooks and with a slight port**

SENSOGAN®  
AURIGAN

Weymouth with a slight port that offers space for the tongue without squeezing the sensitive palate. The mouthpiece curves around the tongue in a smooth bow. A good choice for horses that have issues with the contact.

article no.	size (mm)	qualities available		size (inch)	thickness (mm)	cheek (cm)	lower cheeks (cm)	box quantity
42267	125	79		5.	18	13	7	2 *
	130		89	5.1/8	18	13	7	2
	135	79	89	5.1/4	18	13	7	2 *
	140		89	5.1/2	18	13	7	2
	145		89	5.3/4	18	13	7	2 *
	155		89	6.1/8	18	13	7	2
42257	115		89	4.1/2	18	11	5	2
	125	79		5.	18	11	5	2
	135	79		5.1/4	18	11	5	2
	145		89	5.3/4	18	11	5	2



42267 ... 79  
7 cm

42257  
5 cm



SENSOGAN®  
AURIGAN

**Weymouth bit “FC”**

The FC Special Weymouth is characterised by an especially low and wide port that offers broad space for the tongue without arching upwards. Therefore prevents uncomfortable pressure on the sensitive palate. A good choice for horses with a flat palatal arch and a fleshy or thick tongue.



42251...78 5 cm      42261...78 7 cm      42261...89 7 cm      42251...89 5 cm

article no.	size (mm)	qualities available		size (inch)	thickness (mm)	cheek (cm)	lower cheeks (cm)	box quantity
42261	125	78	89	5.	18	13	7	2 *
	135	78		5.1/4	18	13	7	2 *
	145	78	89	5.3/4	18	13	7	2 *
42251	125	78	89	5.	18	11	5	2 *
	135	78		5.1/4	18	11	5	2 *
	145	78	89	5.3/4	18	11	5	2 *

**Weymouth bit “FC”  
stainless steel**



The FC Special Weymouth is characterized by an especially low and wide port that offers broad space for the tongue without arching upwards. Therefore prevents uncomfortable pressure on the sensitive palate. A good choice for horses with a flat palatal arch and a fleshy or thick tongue.



article no.	size (mm)	qualities available		size (inch)	thickness (mm)	cheek (cm)	lower cheeks (cm)	box quantity
42261	115	56		4.1/2	16	11	5	2
	125	56		5.	16	13	7	2
	135	56		5.1/4	16	13	7	2
	145	56		5.3/4	16	13	7	2

**French Weymouth**

SENSOGAN®

The French Weymouth, slightly curved without port, evenly distributes the pressure to the whole tongue width and the lower jaw bones. Perfect for horses with small oral cavity.



article no.	size (mm)	qualities available		size (inch)	thickness (mm)	cheek (cm)	lower cheeks (cm)	box quantity
42264	125	78		5.	14	13	7	2 *
	135	78		5.1/4	14	13	7	2 *
	145	78		5.3/4	14	13	7	2 *

**KK Dressage bit**  
thickness: 18 mm



The mouthpiece of the KK Dressage Weymouth is shaped to the anatomy of the horse's mouth. It prevents pressure on the horse's palate as the port is angled forward by 45°. The pressure is evenly distributed on the whole tongue when the reins are pulled. The wide and forward turned port gives small and normal tongues enough room.

article no.	size (mm)	qualities available		size (inch)	thickness (mm)	cheek (cm)	lower cheeks (cm)	box quantity	
42281	120	78	88	89	4.3/4	18	13	7	2 *
	130	78		89	5.1/8	18	13	7	2 *
	140	78	88	89	5.1/2	18	13	7	2 *
42181	120	78	88		4.3/4	18	11	5	2 *
	130	78			5.1/8	18	11	5	2 *
	140	78	88		5.1/2	18	11	5	2 *



**KK Dressage bit**  
thickness: 21 mm



The mouthpiece of the KK Dressage Weymouth is shaped to the anatomy of the horse's mouth. It prevents pressure on the horse's palate as the port is angled forward by 45°. The pressure is evenly distributed on the whole tongue when the reins are pulled. The wide and forward turned port gives small and normal tongues enough room.

article no.	size (mm)	qualities available		size (inch)	thickness (mm)	cheek (cm)	lower cheeks (cm)	box quantity	
42280	125			89	5.	21	13	7	2
	135			89	5.1/4	21	13	7	2
42180	125			89	5.	21	11	5	2
	135			89	5.1/4	21	11	5	2



**Klaus Balkenhol**

"Sprengrer and I have worked closely together on many innovative ideas and over the years we have kept developing new products. I am delighted with Sprengrer's commitment to horse and rider welfare and the incomparable quality of their products."



**Curb chain for Weymouth bits**

article no.	qualities available			links (pc)	length (cm)	box quantity
45055	024	55	88	24	23 / 21	10 *
	028		88	28	25	10



**SPRENGER KD Curb chain**

The KD curb chain has left and right twisted curb links. It keeps a weymouth more balanced and leads an even distribution of pressure on the entire tongue.

article no.	qualities available			links (pc)	length (cm)	box quantity
45050	024	55		24	22	1 *

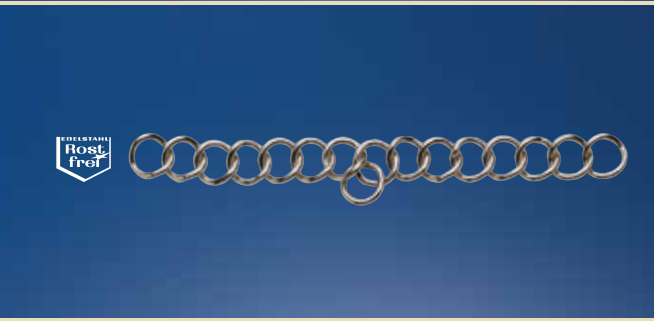

**Curb chain for Driving bits**

article no.	qualities available			links (pc)	length (cm)	box quantity
45053	015	56		15	27	10



**Curb chain hooks**

article no.	qualities available			length (cm)	box quantity
<b>Curb chain hooks, flat (per pair)</b>					
45065	000	55		4,5	10 *
<b>Curb chain hooks for Weymouth bits (right and left)</b>					
45071	000	55	88	4	10 *
<b>Curb chain hooks for Driving bits (right and left)</b>					
45076	000	55		4	10



**Curb chain guard  
rubber black  
optimum fit**

article no.	qualities available			box quantity
45249	000		71	10 *



**Curb chain guard  
rubber black**

article no.	qualities available			box quantity
45250	060		71	25 *

**KK ULTRA bradoon** (Info page 12)



article no.	size (mm)	qualities available		size (inch)	thickness (mm)	ring-Ø (mm)	box quantity
40201	115	78		4.1/2	12	55	2 *
	125	78		5.	12	55	2 *
	135	78		5.1/4	12	55	2 *
	145	78		5.3/4	12	55	2 *
40200	105	78	79 88	4.1/8	14	55	2
	115	78	79 88	4.1/2	14	55	2 *
	125	78	79 88	5.	14	55	2 *
	135	78	79 88	5.1/4	14	55	2 *
	145	78	79 88	5.3/4	14	55	2 *
	155	78	79 88	6.1/8	14	55	2 *
40224	115	78		4.1/2	16	55	2 *
	125	78		5.	16	55	2 *
	135	78		5.1/4	16	55	2 *
	145	78		5.3/4	16	55	2 *



**WH ULTRA bradoon** (Info page 25)



article no.	size (mm)	qualities available		size (inch)	thickness (mm)	ring-Ø (mm)	box quantity
40227	120	78	88	4.3/4	14	55	2 *
	130	78	88	5.1/8	14	55	2 *
	140	78		5.1/2	14	55	2 *
	150		88	6.	14	55	2 *
40226	120	78		4.3/4	16	55	2 *
	130	78	88	5.1/8	16	55	2 *
	140	78	88	5.1/2	16	55	2 *
	150	78	88	6.	16	55	2 *



**Dynamic RS bradoon** (Info page 19)



article no.	size (mm)	qualities available		size (inch)	thickness (mm)	ring-Ø (mm)	box quantity
40214	105	78	88	4.1/8	14	55	2
	110		88	4.1/4	14	55	2
	115	78	88	4.1/2	14	55	2
	125	78	88	5.	14	55	2 *
	135	78	88	5.1/4	14	55	2 *
	145	78	88	5.3/4	14	55	2 *
	155	78	88	6.1/8	14	55	2 *



**novocontact bradoon**



The novocontact bradoon has a large contact surface despite of the relative thin thickness of 12mm. In combination with a Weymouth the innovative shape of this bit enables the optimal utilisation of the limited space in the horse's mouth resulting in particularly soft impact.

article no.	size (mm)	qualities available		size (inch)	thickness (mm)	ring-Ø (mm)	box quantity
40256	115	78		4.1/2	12	55	2 *
	125	78		5.	12	55	2 *
	135	78		5.1/4	12	55	2 *
	145	78		5.3/4	12	55	2 *



**Bradoon stainless steel**



article no.	size (mm)	qualities available		size (inch)	thickness (mm)	ring-Ø (mm)	box quantity
40904	105	56		4.1/8	14	55	2 *
	115	56		4.1/2	14	55	2 *
	125	56		5.	14	55	2 *
	135	56		5.1/4	14	55	2 *
	145	56		5.3/4	14	55	2 *







**KK ULTRA Eggbutt bradoon** (Info p.13)  
double jointed



article no.	size (mm)	qualities available		size (inch)	thickness (mm)	ring-Ø (mm)	box quantity
<b>40367</b>	<b>115</b>	<b>78</b>	<b>89</b>	4.1/2	14	55	2 *
	<b>125</b>	<b>78</b>	<b>89</b>	5.	14	55	2 *
	<b>135</b>	<b>78</b>		5.1/4	14	55	2 *
	<b>145</b>	<b>78</b>		5.3/4	14	55	2 *
	<b>155</b>	<b>78</b>	<b>89</b>	6.1/8	14	55	2



**Dynamic RS Eggbutt bradoon** (Info p.18)  
double jointed



article no.	size (mm)	qualities available		size (inch)	thickness (mm)	ring-Ø (mm)	box quantity
<b>40248</b>	<b>115</b>	<b>78</b>		4.1/2	14	55	2 *
	<b>125</b>	<b>78</b>		5.	14	55	2 *
	<b>135</b>	<b>78</b>		5.1/4	14	55	2 *
	<b>145</b>	<b>78</b>		5.3/4	14	55	2 *



**Eggbutt bradoon**  
single jointed



article no.	size (mm)	qualities available		size (inch)	thickness (mm)	ring-Ø (mm)	box quantity
<b>40362</b>	<b>120</b>	<b>78</b>	<b>89</b>	4.3/4	16	55	2
	<b>130</b>	<b>78</b>	<b>89</b>	5.1/8	16	55	2
	<b>140</b>	<b>78</b>	<b>89</b>	5.1/2	16	55	2



**Dynamic RS Eggbutt bradoon** (Info p.20)  
single jointed



article no.	size (mm)	qualities available		size (inch)	thickness (mm)	ring-Ø (mm)	box quantity
<b>40249</b>	<b>115</b>	<b>78</b>		4.1/2	14	55	2 *
	<b>125</b>	<b>78</b>		5.	14	55	2 *
	<b>135</b>	<b>78</b>		5.1/4	14	55	2 *
	<b>145</b>	<b>78</b>		5.3/4	14	55	2 *

**TURNADO bradoon** (Info page 32)



article no.	size (mm)	qualities available		size (inch)	thickness (mm)	ring-Ø (mm)	box quantity
40286	125	78	88	5.	14	55	2 *
	135	78	88	5.1/4	14	55	2 *
	145	78		5.3/4	14	55	2 *
	155	78	88	6.1/8	14	55	2 *



**Dynamic RS bradoon** (Info page 19)



article no.	size (mm)	qualities available		size (inch)	thickness (mm)	ring-Ø (mm)	box quantity
40215	120	78	88	4.3/4	14	55	2 *
	130	78		5.1/8	14	55	2 *
	140	78	88	5.1/2	14	55	2 *
	150	78	88	6.	14	55	2 *



**novocontact bradoon**



The novocontact bradoon has a large contact surface despite of the relative thin thickness of 12mm. In combination with a Weymouth the innovative shape of this bit enables the optimal utilisation of the limited space in the horse's mouth resulting in particularly soft impact.

article no.	size (mm)	qualities available		size (inch)	thickness (mm)	ring-Ø (mm)	box quantity
40240	115	78		4.1/2	12	55	2 *
	125	78		5.	12	55	2 *
	135	78		5.1/4	12	55	2 *
	145	78		5.3/4	12	55	2 *



**KK bradoon (anatomically shaped)**



article no.	size (mm)	qualities available		size (inch)	thickness (mm)	ring-Ø (mm)	box quantity
40222	120	78	88	4.3/4	14	55	2 *
	130	78	88	5.1/8	14	55	2 *
	140	78	88	5.1/2	14	55	2 *
	150	78	88	6.	14	55	2 *



**Bradoon**



article no.	size (mm)	qualities available		size (inch)	thickness (mm)	ring-Ø (mm)	box quantity
40212	120	78	79	4.3/4	12	55	2 *
	130	78	79	5.1/8	12	55	2 *
	140	78	79	5.1/2	12	55	2 *
	150	78	79	6.	12	55	2 *
40234	125	78	88	5.	14	55	2 *
	135	78	88	5.1/4	14	55	2 *
	145	78	88	5.3/4	14	55	2 *
40236	120	78		4.3/4	16	55	2 *
	130	78		5.1/8	16	55	2 *
	140	78		5.1/2	16	55	2 *
	150	78		6.	16	55	2 *



**Bradoon stainless steel**



article no.	size (mm)	qualities available		size (inch)	thickness (mm)	ring-Ø (mm)	box quantity
40202	095	56		3.3/4	14	40	2
	100	56		4.	14	40	2
	115	56		4.1/2	14	55	2
	125	56		5.	14	55	2
	135	56		5.1/4	14	55	2
	145	56		5.3/4	14	55	2
	155	56		6.1/8	14	55	2





Loose Ring snaffle, single jointed

CUPLUS

article no.	size (mm)	qualities available	size (inch)	thickness (mm)	ring-Ø (mm)	box quantity
40951	115	94	4.1/2	16	55	5 *
	125	94	5.	16	70	5 *
	135	94	5.1/4	16	70	5 *
	145	94	5.3/4	16	70	5 *
40952	925	94	5.	18	70	5 *
	935	94	5.1/4	18	70	5 *
	945	94	5.3/4	18	70	5 *



Loose Ring snaffle, double jointed

CUPLUS

article no.	size (mm)	qualities available	size (inch)	thickness (mm)	ring-Ø (mm)	box quantity
40905	115	94	4.1/2	16	55	5 *
	125	94	5.	16	70	5 *
	135	94	5.1/4	16	70	5 *
	145	94	5.3/4	16	70	5 *
40908	125	94	5.	18	70	5 *
	135	94	5.1/4	18	70	5 *
	145	94	5.3/4	18	70	5 *
	155	94	6.1/8	18	70	5 *



Eggbutt bit, double jointed

CUPLUS

article no.	size (mm)	qualities available	size (inch)	thickness (mm)	ring-Ø (mm)	box quantity
40365	125	94	5.	16	70	2 *
	135	94	5.1/4	16	70	2 *
	145	94	5.3/4	16	70	2 *



2-TYPE bit, double jointed

CUPLUS

article no.	size (mm)	qualities available	size (inch)	thickness (mm)	ring-Ø (mm)	box quantity
40313	125	94	5.	16	70	2 *
	135	94	5.1/4	16	70	2 *
	145	94	5.3/4	16	70	2 *



3-TYPE bit, double jointed

CUPLUS

article no.	size (mm)	qualities available	size (inch)	thickness (mm)	ring-Ø (mm)	box quantity
40314	125	94	5.	16	70	2 *
	135	94	5.1/4	16	70	2 *
	145	94	5.3/4	16	70	2 *



**KK ULTRA Liverpool Driving bit**  
**double jointed**  
**flexible cheeks with 2 slots**



Due to the double jointed mouthpiece the bit matches the shape of the horse's mouth. The pressure disperses over the tongue-halves, which makes it easier to give precise aids.

article no.	size (mm)	qualities available	size (inch)	thickness (mm)	box quantity
43172	120	88	4.3/4	18	2
	130	88	5.1/8	18	2
	140	88	5.1/2	18	2
	150	88	6.	18	2



**H0 Liverpool Driving bit, curved Mullen Mouthpiece**  
**fixed cheeks with 2 slots**



The smooth and rounded port is angled forward and offers optimal comfort for the horse's mouth. The slanting mouthpiece evenly distributes the pressure to the whole tongue. This bit takes advantage of the exceptional sensitivity of the tongue.

article no.	size (mm)	qualities available	size (inch)	thickness (mm)	box quantity
43168	125	88	5.	19	2
	135	88	5.1/4	19	2
	145	88	5.3/4	19	2



**Comfort Mouth Liverpool Driving bit**  
**fixed cheeks with 2 slots**



Ideal mouthpiece giving even distribution of pressure on the tongue, keeping the horse on the bit. A good choice for introducing younger horses to the driving. Highly recommended for horses with long and fleshy tongues as the mouthpiece offers broad space for the tongue.

Recommended by Georg von Stein and Michael Brauchle.

article no.	size (mm)	qualities available	size (inch)	thickness (mm)	box quantity
43179	125	88	5.	16	2
	135	88	5.1/4	16	2
	145	88	5.3/4	16	2



**Georg von Stein**

(Mannschafts-Silbermedaille bei der Europameisterschaft 2015 und Weltmeisterschaft 2014)  
 (Team silver medal winner at: European Championships 2015 and World Championships 2014)







**KK Liverpool Driving bit**  
fixed cheeks with 2 slots



The ergonomically formed mouthpiece is angled forward by 45°. It distributes the pressure to the tongue and not to the palate. The wide and turned port gives small and normal tongues enough room.

article no.	size (mm)	qualities available		size (inch)	thickness (mm)	box quantity
43125	125		88	5.	21	2
	135		88	5.1/4	21	2



**Liverpool Driving bit with curved Mullen Mouthpiece**  
fixed cheeks with 2 slots



The flat and widened port provides a comfortable position in the horse's mouth.

article no.	size (mm)	qualities available		size (inch)	thickness (mm)	box quantity
43144	125	56		5.	16	2
	135	56		5.1/4	18	2
	145	56		5.3/4	18	2



43146

43150

**Liverpool Driving bit with curved Mullen Mouthpiece**  
fluted on one side



article no.	size (mm)	qualities available		size (inch)	thickness (mm)	box quantity
<b>fixed cheeks with 3 slots</b>						
43146	135	40		5.1/4	16	2
	145	40		5.3/4	16	2
<b>fixed cheeks with 3 slots and bottem bar</b>						
43150	135	40		5.1/4	16	2
	145	40		5.3/4	16	2



**Liverpool Driving bit with straight Mullen Mouthpiece**  
fluted on one side, flexible cheeks with 3 slots



article no.	size (mm)	qualities available		size (inch)	thickness (mm)	box quantity
43140	135	56		5.1/4	16	2
	145	56		5.3/4	16	2



**Loose Ring snaffle with 4 rings**



article no.	size (mm)	qualities available		size (inch)	thickness (mm)	ring-Ø (mm)	box quantity
40654	125	56		5.	20	65	5
	135	56		5.1/4	20	65	5
	145	56		5.3/4	20	65	5

**HO Butterfly Liverpool bit**  
curved Mullen Mouthpiece



The smooth and rounded port is angled forward and offers optimal comfort for the horse's mouth. The slanting mouthpiece evenly distributes the pressure to the whole tongue. This bit takes advantage of the exceptional sensitivity of the tongue.

article no.	size (mm)	qualities available	size (inch)	thickness (mm)	box quantity
<b>fixed cheeks</b>					
43169	125	89	5.	19	2
	135	89	5.1/4	19	2
	145	89	5.3/4	19	2



**2 Ring Butterfly Liverpool bit**  
curved Mullen Mouthpiece



The flat and widened port provides a comfortable position in the horse's mouth.

article no.	size (mm)	qualities available	size (inch)	thickness (mm)	box quantity
<b>fixed cheeks</b>					
43116	135	56	5.1/4	19	2
	145	56	5.3/4	19	2



**2 Ring Butterfly Liverpool bit**  
curved Mullen Mouthpiece



The mouthpiece is slightly curved and evenly distributes pressure to the whole tongue.

article no.	size (mm)	qualities available	size (inch)	thickness (mm)	box quantity
<b>fixed cheeks</b>					
43109	135	56	5.1/4	16	2
	145	56	5.3/4	16	2



**2 Ring Butterfly Liverpool bit**  
curved mouthpiece, fluted on one side



article no.	size (mm)	qualities available	size (inch)	thickness (mm)	box quantity
<b>flexible cheeks</b>					
43110	125	56	5.	16	2
	135	56	5.1/4	16	2
	145	56	5.3/4	16	2
	160	56	6.1/4	16	2
	170	56	6.3/4	16	2



**2 Ring Butterfly Liverpool Pony bit**  
curved mouthpiece, fluted on one side



article no.	size (mm)	qualities available	size (inch)	thickness (mm)	box quantity
<b>flexible cheeks</b>					
43098	090	56	3.3/4	12	2
	100	56	4.	12	2
	115	56	4.1/2	12	2



# STIRRUPS

**SPRENGER offers highest quality.**

SPRENGER stirrups are subjected to the highest quality standards. Extensive tests are therefore carried out before a product is introduced to the market.

Quality checks – like pulling tests – are standardised with machines in our premises. SPRENGER contacted the Institute for Research and Development (FES) in Berlin for the first time more than 20 years ago to obtain the most exact knowledge of the forces which are effectively at work during riding for developing new stirrups. Substantial research has been done. Stirrups were equipped with special strain gauges which

transmitted the tensile momentums via radio. Tests were then made on a military terrain under competition conditions.

It turned out that forces can occur in the stirrup which can equal up to tripled bodyweight. However, the experience of many years has shown that even stirrups with a breaking strength of 600 kg can break. Therefore, SPRENGER only offers the highest quality to guarantee optimal security. Our safety standard for stirrups is a breaking strength of 800 kg.

## 2.0

<b>Stirrups</b> .....	<b>68-75</b>
<b>2.1 Jointed stirrups</b> .....	<b>70-73</b>
Bow Balance	70-71
System 4 Stirrups	72-73
<b>2.2 Stirrups</b> .....	<b>74-75</b>
<b>2.3 Stirrup pads</b> .....	<b>71, 73, 75</b>

#### QUALITIES AVAILABLE

---

<b>00</b>	miscellaneous
<b>55</b>	HS-stainless steel
<b>56</b>	stainless steel
<b>61</b>	HS-stainless steel, anthracite
<b>62</b>	HS-stainless steel, bronze
<b>71</b>	rubber black
<b>72</b>	rubber white
<b>88</b>	Aurigan

#### PLEASE NOTE

Quality keys and dimensions can also be found on the last page of this catalogue.



# SPRENGER BowBalance Stirrups

## Jos Lansink

"For many years I have been riding with Sprenger bits and stirrups. Reliability and safety are first for me and I can truly rely on Sprenger."



## SPRENGER BOW BALANCE Stirrups provide supreme comfort.

Bow Balance stirrups are equipped with the internationally approved System-4 technology which is characterized by a forward and backward moveable tread which turns the rider's heels in the correct low position. The movable tread enables permanent contact and additionally provides very good foothold and relaxed calves.

### The bow that puts you on a winning curve.

The latest stirrup design ensures an improved leg position. The changed weight ratio on these stirrups results in perfect balance and greater comfort for the rider. The widened tread is made out of two types of rubber properties and takes effect in shock absorbing grip.

Flexible in four directions it softens the impact on the rider's cartilage and ligaments without creating an unstable feeling for the rider. Bow Balance design provides easy "pick up" upon mounting as they require very little effort on the rider's part – a simple touch of the foot to the stirrup and it gently folds onto the rider's foot.

Bow Balance Stirrups – for a smart riding experience.

### The advantages of the SPRENGER Bow Balance Stirrups:

bow form for a perfect fit

superb strength and enhanced security, pivoting into 4 directions simultaneously

maximum comfort

tread with two types of rubber hardness for a better grip

softens the impact on cartilage and ligaments

wide tread for a perfect balance



European patent no. EP 1 003 688 B1 / EP 1 999 063 B1  
US patent no. US 6,330,781 B2

**Bow Balance Stirrups**  
stainless steel



The Bow Balance stirrups provide supreme comfort. Due to the rubber covers the actual size is a little smaller.

article no.	qualities available			size		suitable pads	box quantity
				(mm)	(inch)		
44266	112	55		110	4.1/4	44140 110 00	2 *
	122	55		120	4.3/4	44140 120 00 / 56	2 *
	132	55		130	5.1/8	44140 130 00	2 *



**Bow Balance Stirrups**  
stainless steel – anthracite, bronze



Due to the rubber covers the actual size is a little smaller.

article no.	qualities available			size		suitable pads	box quantity
				(mm)	(inch)		
<b>anthracite</b>							
44266	122	61		120	4.3/4	44140 120 00 / 56	1 *
<b>bronze</b>							
44266	122	62		120	4.3/4	44140 120 00 / 56	1 *



44266... 61

44266... 62

**Stirrup pads**  
rubber, black/blue for Bow Balance

European patent no. EP 1 999 064 B1 / US patent no. US 7,934,363 B2

article no.	qualities available			size		box quantity
				(mm)	(inch)	
44140	110	00		110	4.1/4	5 *
	120	00		120	4.3/4	5 *
	130	00		130	5.1/8	5 *



**Stirrup pads**  
stainless steel for Bow Balance



article no.	qualities available			size		box quantity
				(mm)	(inch)	
44140	120	56		120	4.3/4	5 *

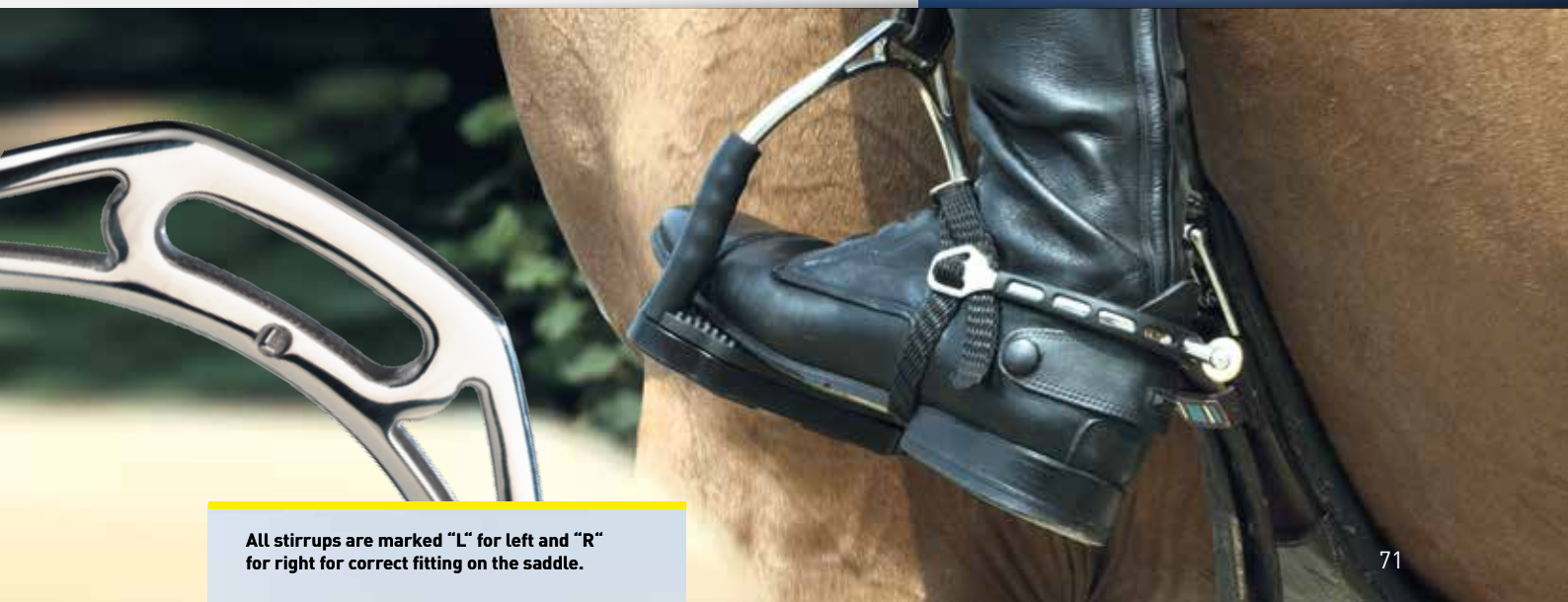

All stirrups are marked "L" for left and "R" for right for correct fitting on the saddle.

2.0 STIRRUPS

# SPRENGER System-4 Jointed Stirrups

SPRENGER System-4 Jointed Stirrups relieve hips, knees and ankles during riding and particularly spares ligaments and menisci. This patented System-4 is an epitome for comfortable riding. It has unquestionable confidence and is used by both, leisure and professional riders.

Success – as in most cases – brings plagiarism. The copies you find in the market are often of poor quality and can generate a major safety risk. Therefore only trust the original from SPRENGER.



## The advantages of the SPRENGER System-4 Jointed Stirrups:

- pivoting into 4 directions simultaneously
- softens the impact on cartilage and ligaments
- the heel is always in the correct low position
- superb strength
- great comfort

European patent no. EP 1 003 688 B1  
US patent no. US 6,330,781 B1  
EU-trademark no. 001599620





**System-4 Stirrups**  
stainless steel



Due to the rubber covers the actual size is a little smaller.

article no.	qualities available			size		suitable pads	box quantity
	112	122	132	(mm)	(inch)		
44236	55			110	4.1/4	44240 110 71	2 *
	55			120	4.3/4	44240 120 71 44242 120 56	2 *
	55			130	5.1/8	44240 130 71	2 *



**System-4 Stirrups**  
stainless steel with offset eye



Due to the rubber covers the actual size is a little smaller.

article no.	qualities available			size		suitable pads	box quantity
	122			(mm)	(inch)		
44234	55			120	4.3/4	44240 120 71 44242 120 56	2 *



**Stirrup pads**  
rubber, black for System-4

article no.	qualities available			size		box quantity
	110	120	130	(mm)	(inch)	
44240	71			110	4.1/4	5 *
	71			120	4.3/4	5 *
	71			130	5.1/8	5 *



**Stirrup pads**  
stainless steel for System-4



article no.	qualities available			size		box quantity
	120			(mm)	(inch)	
44242	56			120	4.3/4	5 *



**Markus und Johannes Ehning**

"In horse riding safety is a must! This is why we only use Sprenger's System-4 and Bow Balance stirrups that fulfil our high requirements on quality and functionality."





44244 1... 56

44244 8... 56

**FILLIS-Stirrups**  
stainless steel



article no.	qualities available			size (mm) (inch)		suitable pads	box quantity
<b>with white pad</b>							
<b>44244</b>	<b>112</b>	<b>56</b>		110	4.1/4	44242 110 72	5 *
	<b>122</b>	<b>56</b>		120	4.3/4	44242 121 72	5 *
	<b>132</b>	<b>56</b>		127	5.	44242 130 72	5 *
<b>with black pad</b>							
<b>44244</b>	<b>812</b>	<b>56</b>		110	4.1/4	44240 110 71	5 *
	<b>822</b>	<b>56</b>		120	4.3/4	44242 121 71	5 *



**FILLIS-Stirrups**



article no.	qualities available			size (mm) (inch)		suitable pads	box quantity
<b>golden colour</b>							
<b>44245</b>	<b>122</b>	<b>88</b>		120	4.3/4	44242 121 72	1



**ISI-Stirrups**  
stainless steel



article no.	qualities available			size (mm) (inch)		suitable pads	box quantity
<b>offset eye</b>							
<b>44224</b>	<b>122</b>	<b>56</b>		120	4.3/4	44242 121 72	5 *



**Stirrups with curved side**  
stainless steel



article no.	qualities available			size (mm) (inch)		suitable pads	box quantity
<b>44249</b>	<b>122</b>	<b>56</b>		120	4.3/4	44242 121 72	5

**Peacock Stirrups**  
stainless steel



article no.	qualities available				size		suitable pads	box quantity
	122	56			(mm)	(inch)		
44250	122	56			120	4.3/4	44242 121 72	5
<b>Rubber rings, white for 44250</b>								
44251	000	00						20
<b>Leather straps, brown for 44250</b>								
44252	000	00						20



**Icelandic stirrups with pad**  
stainless steel



article no.	qualities available				size		suitable pads	box quantity
	122	56			(mm)	(inch)		
44256	122	56			120	4.3/4	44235 120 71	5



**Stirrup pads**  
rubber, black

article no.	qualities available				size		box quantity
	110	121	71		(mm)	(inch)	
44240	110		71		110	4.1/4	5 *
44242	121		71		120	4.3/4	5 *
44240	130		71		130	5.1/8	5 *



**Stirrup pads**  
rubber, white

article no.	qualities available				size		box quantity
	110	121	72		(mm)	(inch)	
44242	110		72		110	4.1/4	5 *
	121		72		120	4.3/4	5 *
	130		72		130	5.1/8	5 *



**Stirrup pads**  
stainless steel



article no.	qualities available				size		box quantity
	120	56			(mm)	(inch)	
44242	120	56			120	4.3/4	5 *



**Stirrup pads**  
rubber, black for Icelandic stirrups

article no.	qualities available				size		box quantity
	120	71			(mm)	(inch)	
44235	120	71			120	4.3/4	10



# SPURS

Guaranteed quality and highest comfort.

More than 100 different models in various materials offer a wide range to suit individual requirements. SPRENGER spurs ensure a gentle but precise communication between horse and rider. High quality spurs are made of German Silver and Stainless Steel.

German Silver and Stainless Steel Spurs are guaranteed against breakage!

Klaus Balkenhol, the former Olympic champion and the trainer of the US Dressage team, has developed the BALKENHOL SPURS in close partnership with SPRENGER.

The SPRENGER tradition of developing innovative and high quality products is continued with these spurs. The Balkenhol spurs fit perfectly to your riding boots. No pressure and no movement give the desired effect.



Spurs	76-85
3.1 Spurs ULTRA fit Premium	78-79
3.2 Spurs ULTRA fit EXTRA GRIP Premium	80
3.3 Spurs ULTRA fit EXTRA GRIP Premium "Black Series"	81
3.4 German Silver spurs	82-83
3.5 Spurs, nevrerrust	84
3.6 Spur straps / Spur protector	85

# 3.0

3.0 SPURS

-  001 Ø 14 mm  
**fine point rowel**
-  003 Ø 14 mm  
**little round rowel**
-  004 Ø 22 mm  
**9 point big rowel**
-  005 Ø 21 mm  
**big round rowel**
-  006 Ø 16 mm  
**little round rowel**
-  009 Ø 19 mm  
**Comfort Roller**

## QUALITIES AVAILABLE

- 00 miscellaneous
- 04 steel brass plated
- 40 German Silver highly polished
- 44 nevrerrust mechanically polished chrome plated
- 55 HS-stainless steel
- 61 HS-stainless steel, anthracite
- 62 HS-stainless steel, bronze
- 71 rubber black

## PLEASE NOTE

Quality keys and dimensions can also be found on the last page of this catalogue.  
D = Spurs for ladies, H = Spurs for men.









**ULTRA fit stainless steel spurs with an elegant and fine Balkenhol fastening**



Developed in cooperation with Klaus Balkenhol. A spur that fits perfectly on your riding boot. This unique fit and design eliminates pressure and movement thus providing correct spur performance and protection of the boot leather.

European patent no. EP 1 094 730 B1 + EP 1 004 253 B1  
 US patent no. US 6,381,931 B2 + US 6,353,980 B1



article no.	qualities available	neck size (mm)	neck size (inch)	available with the following rowels	box quantity
47405	000 55	8	5/16		5 *
47415	000 55	15	5/8		5 *
47421	000 55	20	3/4		5 *
47425	000 55	25	1.		5 *
47425	... 55	30 <sup>(1)</sup>	1.1/4	001 004 005 006	2 *
				<sup>(1)</sup> incl. rowel 	
47425	100 55	25	1.		5 *
47425	... 55	30 <sup>(1)</sup>	1.1/4	104 106	2 *
				<sup>(1)</sup> incl. rowel 	
47431	000 55	30	1.1/4		5 *
47435	000 55	35	1.3/8		5 *
47435	... 55	40 <sup>(1)</sup>	1.5/8	004 005 006	2 *
				<sup>(1)</sup> incl. rowel 	
47435	100 55	35	1.3/8		5 *
47435	... 55	40 <sup>(1)</sup>	1.5/8	104 106	2 *
				<sup>(1)</sup> incl. rowel 	
47440	000 55	40	1.5/8		5 *
47440	... 55	45 <sup>(1)</sup>	1.3/4	004 005	2 *
				<sup>(1)</sup> incl. rowel 	



Klaus Balkenhol has won numerous medals at European, World Championships and Olympic Games in his time as a rider and national trainer of the German and American teams. His most successful current students are Laura Tomlinson and his daughter Anabel Balkenhol.



Klaus Balkenhol



article no.	qualities available	neck size (mm) (inch)		available with the following rowels	box quantity
-------------	---------------------	-----------------------	--	-------------------------------------	--------------

47427	000	55		20	3/4	hammer spur	5 *
-------	-----	----	--	----	-----	-------------	-----

47458	000	55		25	1.		5 *
-------	-----	----	--	----	----	--	-----

**Comfort Roller**

- unique innovative design
- softer because of the rolling action
- with big round brass rowel
- faster and more direct flank contact (horizontal rowel)

47451	009	55		25 <sup>(1)</sup>	1.	009	2 *
-------	-----	----	--	-------------------	----	-----	-----

<sup>(1)</sup> incl. rowel

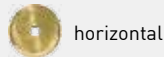

47452	009	55		35 <sup>(1)</sup>	1.3/8	009	2 *
-------	-----	----	--	-------------------	-------	-----	-----

<sup>(1)</sup> incl. rowel

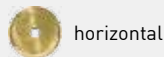

47461	009	55		25 <sup>(1)</sup>	1.	009	2 *
-------	-----	----	--	-------------------	----	-----	-----

<sup>(1)</sup> incl. rowel

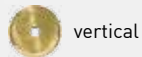

47462	009	55		35 <sup>(1)</sup>	1.3/8	009	2 *
-------	-----	----	--	-------------------	-------	-----	-----

<sup>(1)</sup> incl. rowel

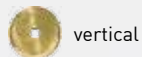

**ULTRA fit spurs**  
stainless steel – anthracite, bronze

47425	000		61	25	1.	anthracite	1 *
-------	-----	--	----	----	----	------------	-----

47425	000		62	25	1.	bronze	1 *
-------	-----	--	----	----	----	--------	-----





**ULTRA fit EXTRA GRIP stainless steel spurs with an elegant and fine Balkenhol fastening**

Developed in cooperation with Klaus Balkenhol. A rubber covered spur for a better fit and an attractive look. A spur that fits perfectly on your riding boots. This unique fit and design eliminates pressure and movement thus providing correct spur performance and protection of the boot leather.

European patent no. EP 1 094 730 B1 + EP 1 004 253 B1 + EP 1 752 056 B1  
 US patent no. US 6,381,931 B2 + US 6,353,980 B1



article no.	qualities available				neck size		available with the following rowels				box quantity
					(mm)	(inch)					

47515	000	55			15	5/8					5 *
-------	-----	----	--	--	----	-----	--	--	--	--	-----

47521	000	55			20	3/4					5 *
-------	-----	----	--	--	----	-----	--	--	--	--	-----

47525	000	55			25	1.					5 *
-------	-----	----	--	--	----	----	--	--	--	--	-----

47525	...	55			30 <sup>(1)</sup>	1.1/4	001	004	005	006	2 *
-------	-----	----	--	--	-------------------	-------	-----	-----	-----	-----	-----

<sup>(1)</sup> incl. rowel



47525	100	55			25	1.					5 *
-------	-----	----	--	--	----	----	--	--	--	--	-----

47531	000	55			30	1.1/4					5 *
-------	-----	----	--	--	----	-------	--	--	--	--	-----

47535	000	55			35	1.3/8					5 *
-------	-----	----	--	--	----	-------	--	--	--	--	-----

47535	...	55			40 <sup>(1)</sup>	1.5/8	004	005	006		2 *
-------	-----	----	--	--	-------------------	-------	-----	-----	-----	--	-----

<sup>(1)</sup> incl. rowel



47535	100	55			35	1.3/8					5 *
-------	-----	----	--	--	----	-------	--	--	--	--	-----

**Comfort Roller**

- unique innovative design
- softer because of the rolling action
- with big round brass rowel
- faster and more direct flank contact (horizontal rowel)

47551	009	55			25	1.	009				2 *
-------	-----	----	--	--	----	----	-----	--	--	--	-----

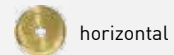

47552	009	55			35	1.3/8	009				2 *
-------	-----	----	--	--	----	-------	-----	--	--	--	-----

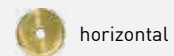

47561	009	55			25	1.	009				2 *
-------	-----	----	--	--	----	----	-----	--	--	--	-----



47562	009	55			35	1.3/8	009				2 *
-------	-----	----	--	--	----	-------	-----	--	--	--	-----

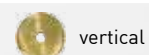

**ULTRA fit EXTRA GRIP spurs “Black Series”**  
with an elegant and fine Balkenhol fastening,  
stainless steel, black, rubber covered



Fits perfectly to Bow Balance Stirrups in anthracite colour and black boots.

Developed in cooperation with Klaus Balkenhol. A rubber covered spur for a better fit and an attractive look. A spur that fits perfectly on your riding boots. This unique fit and design eliminates pressure and movement thus providing correct spur performance and protection of the boot leather.

European patent no. EP 1 094 730 B1 + EP 1 004 253 B1 + EP 1 752 056 B1  
US patent no. US 6,381,931 B2 + US 6,353,980 B1

article no.	qualities available	neck size		box quantity
		(mm)	(inch)	
47515	000 61	15	5/8	1 *
47521	000 61	20	3/4	1 *
47525	100 61	25	1.	1 *
47535	100 61	35	1.3/8	1 *

**Spur straps for “Black Series”**  
buckle, stainless steel black

Fits perfectly to Bow Balance Stirrups in anthracite colour and black boots.

article no.	qualities available	length		material	box quantity
		(mm)	(inch)		
49186	045 61	450	17.3/4	smooth leather, black	10 *
49189	045 61	450	17.3/4	plaited perlon, black	10 *







Klaus Balkenhol



**Dressage spurs**  
with an elegant and fine Balkenhol fastening

Developed in cooperation with Klaus Balkenhol.

article no.	qualities available	neck size (mm) (inch)	available with the following rowels	box quantity
-------------	---------------------	-----------------------	-------------------------------------	--------------

**Spurs "Balkenhol"**

47070	000	40	H	35	1.3/8		2 *
47170	000	40	D	35	1.3/8		2 *

47070	004	40	H	40 <sup>(1)</sup>	1.5/8	004	2 *
47170	004	40	D	40 <sup>(1)</sup>	1.5/8	004	2 *

<sup>(1)</sup> incl. rowel



47070	006	40	H	40 <sup>(1)</sup>	1.5/8	006	2 *
47170	006	40	D	40 <sup>(1)</sup>	1.5/8	006	2 *

<sup>(1)</sup> incl. rowel



**Swan Neck spurs**

47075	000	40		40	1.5/8		2 *
47075	...	40		45 <sup>(1)</sup>	1.3/4	003 004	2

<sup>(1)</sup> incl. rowel



**Spurs "HS-Dressage"**

47079	000	40	H	40	1.5/8		2 *
47179	000	40	D	40	1.5/8		2 *

47079	004	40	H	45 <sup>(1)</sup>	1.3/4	004	2 *
47179	004	40	D	45 <sup>(1)</sup>	1.3/4	004	2 *

<sup>(1)</sup> incl. rowel



47079	005	40	H	45 <sup>(1)</sup>	1.3/4	005	2
47179	005	40	D	45 <sup>(1)</sup>	1.3/4	005	2 *

<sup>(1)</sup> incl. rowel



article no.	qualities available	neck size		available with the following rowels	box quantity
		(mm)	(inch)		

**GDs spurs**

These spurs with a two level offset neck offer optimal support when riding with long legs. From the correct position (vertical line from head over the hip to the heel) the aid is given specifically due to the offset thorn without the rider being forced to turn the feet outwards. Using these spurs enables the rider to keep constant knee contact to the saddle when riding. Horse and rider are more balanced.

47078	000	40			40	1.5/8	2
-------	-----	----	--	--	----	-------	---

**Offset spurs (neck slanting)**

47120	000	40	D		30	1.1/4	2 *
-------	-----	----	---	--	----	-------	-----

**Heel fixing spurs**

48043	000	40			18	45/64	5
-------	-----	----	--	--	----	-------	---



3.0 SPURS





## No guarantee on breaking for quality 44

article no.	qualities available	neck size		available with the following rowels	box quantity
		(mm)	(inch)		

47124	000 44	D	15	5/8	Spurs for ponies	5 *
-------	--------	---	----	-----	------------------	-----

47025	000 44	H	20	3/4		5 *
-------	--------	---	----	-----	--	-----

47125	000 44	D	20	3/4		5 *
-------	--------	---	----	-----	--	-----

	800 44	D	20	3/4	with perlon straps	5
--	--------	---	----	-----	--------------------	---

47035	000 44	H	30	1.1/4		5
-------	--------	---	----	-------	--	---

47135	000 44	D	30	1.1/4		5 *
-------	--------	---	----	-------	--	-----

47115	000 44	D	15	5/8		5 *
-------	--------	---	----	-----	--	-----

	800 44	D	15	5/8	with perlon straps	5
--	--------	---	----	-----	--------------------	---

47022	000 44	H	35	1.3/8		5
-------	--------	---	----	-------	--	---

47122	000 44	D	30	1.1/4		5 *
-------	--------	---	----	-------	--	-----



Ingrid Klimke's story of success has its origin in Muenster, Westphalia where she trains young horses for international eventing and dressage championships. She won the World Championships of young dressage and eventing horses with Damon Hill (2006) and Sleep Late (1998). The daughter of Olympic Gold Medal Winner Dr. Reiner Klimke also won the Olympic Gold Medal with the German Eventing Team in Hongkong, 2008. She also won the Team Gold Medal at World and European Eventing Championships (2012 Olympic games, 2013 + 2015 European Championships, 2014 World Championships). As the second woman in history of equestrian sports Ingrid Klimke was appointed "Riding Master" by the German Equestrian Federation (FN).

"For many years I have been using SPRENGER bits, spurs and stirrups as my horses feel very comfortable with them and only the best is just good enough for my four-legged sport partners." Ingrid Klimke

article no.	qualities available	length		material	box quantity
		(mm)	(inch)		

**Spur straps**

49184	045	00		450	17.3/4	smooth leather, brown	10 *
49186	045	00		450	17.3/4	smooth leather, black	10 *
49188	045	00		450	17.3/4	plaited perlon, brown	10 *
49189	045	00		450	17.3/4	plaited perlon, black	10 *
	050	00		500	19.3/4	plaited perlon, black	10 *
49189	045		04	450	17.3/4	plaited perlon, black with buckle steel brass plated	10 *

**Spur straps for "Black Series"**

- buckle, stainless steel black

article no.	qualities available	length		material	box quantity		
		(mm)	(inch)				
49186	045	61		450	17.3/4	smooth leather, black	10 *
49189	045	61		450	17.3/4	plaited perlon, black	10 *

**Spur protector, rubber black (1 Set = 10 pairs)**

49190	000		71				1 Set *
-------	-----	--	----	--	--	--	---------



3.0 SPURS





SPRENGER®

HS  
GERMANY  
45280

# GROOMING ITEMS

## Special care

Your horse deserves special care, therefore we offer a varied range of curry combs, brushes and numerous grooming items.

For best results use SPRENGER products.



Grooming items.....	86-98
4.1 Brushes.....	88-89
4.2 Grooming gloves / Cleaning.....	90
4.3 Mane care.....	91
4.4 Curry combs.....	92
4.5 Leather punches and sweat-scrapers.....	93
4.6 Hoof care and bell boots.....	94
4.7 Lunge and bit accessories.....	95
4.8 Bridle and saddle accessories.....	96
4.9 Boot hooks and stretchers.....	97
4.10 Boot jacks.....	98

#### QUALITIES AVAILABLE

00	miscellaneous
01	steel nickel plated
06	steel galvanised
14	steel varnished
49	aluminium mechanically polished
56	stainless steel
71	rubber black
72	rubber white
74	rubber red
75	rubber brown

# 4.0

#### PLEASE NOTE

Quality keys and dimensions can also be found on the last page of this catalogue.



Wooden backed – Made in Germany



**Brush**

made of high quality pear tree wood with bristles of brass wire and black perlon. Web strap, very handy.

article no.	qualities available			measures (mm)	box quantity
45288	000	00		135 x 70	5



**Brush**

made of high quality pear tree wood with grey antistatic natural bristles (also known as "cactus bristles"). Web strap, very handy.

article no.	qualities available			measures (mm)	box quantity
45288	002	00		135 x 70	5



**Mane brush**

body mahogany-coloured, perlon bristles

article no.	qualities available			measures (mm)	box quantity
45289	001	00		180 x 55	5



**Brush – BLUE LINE**

Plastic backed (royal blue/grey) ergonomically formed, handy and trendy

article no.	qualities available			measures (mm)	box quantity
45311	000	00		190 x 85	5

Wooden backed mahogany-coloured with leather strap – Made in Germany

**Body-brush**

black perlon bristles, white surrounded

article no.	qualities available			measures (mm)	box quantity
45280	000	00		210 x 90	5 *



**Body-brush**

Original China black bristles, white surrounded

article no.	qualities available			measures (mm)	box quantity
45283	000	00		210 x 90	5 *



**Body-brush**

SPRENGER's best one: strong tail hair

article no.	qualities available			measures (mm)	box quantity
45284	000	00		215 x 100	5 *



**Body-brush**

Inside tail mixture, surrounded by black natural fibre bristles

article no.	qualities available			measures (mm)	box quantity
45286	000	00		215 x 100	5 *







45275 000 00



45275 001 00



**Curry comb**  
plastic, assorted colours (see picture)

article no.	qualities available			measures (mm)	box quantity
<b>Curry comb</b>					
45275	000	00		170 x 80	50
<b>Curry comb for children</b>					
45275	001	00		140 x 65	10



**Grooming glove**  
rubber with pimples, assorted colours (see picture)

article no.	qualities available			measures (mm)	box quantity
45287	000	00		235 x 115	20

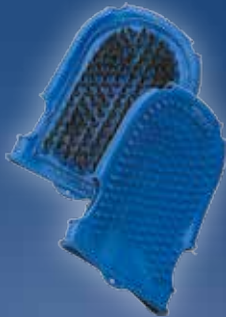

**Grooming glove, dark blue**  
plastic, pimples on one side, bristles on the other side

article no.	qualities available			measures (mm)	box quantity
45287	001	00		170 x 135	25



**Hoof pick with brush – BLUE LINE**  
ergonomically formed, handy and trendy (royal blue/grey)

article no.	qualities available			length (mm)	box quantity
45252	000	00		180	20



45254

45267

**Hoof pick with brush**  
assorted colours (see picture)

article no.	qualities available			length (mm)	box quantity
45254	000	00		180	20

**Hoof pick**  
assorted colours (see picture)

article no.	qualities available			length (mm)	box quantity
45267	000	01		135	50



**Mane brush**

one side black nylon bristles, reverse side rounded nickel plated steel pins on rubber cushion

article no.	qualities available			measures (mm)	box quantity
45281	000	00		230 x 65	5



**Mane brush**

rounded nickel plated steel pins on rubber cushion, web strap

article no.	qualities available			measures (mm)	box quantity
45285	000	00		115 x 70	5



**Thinning scissor**

article no.	qualities available			box quantity
45261	002	01		5



**Folding thinning knife**



article no.	qualities available			box quantity
45406	000	56		10



**Mane rubber rings**

Capacity: approx. 400 pcs.

article no.	qualities available			colour	box quantity
45420	000	00		white	20 Set
45420	002	00		black	20 Set



45420 000 00

45420 002 00



**Rake**  
nickel plated double toothed steel blade, polished wooden handle

article no.	qualities available			measures (mm)	box quantity
45263	000	00		150 x 35	4



**Curry comb**

article no.	qualities available			measures (mm)	box quantity
45271	000	14		240 x 115	20



**Reversible curry comb**  
with changeable spike distance

article no.	qualities available			measures (mm)	box quantity
45271	002	14		225 x 110	10



**Curry comb**  
hand strap made of black imitation leather

article no.	qualities available			measures (mm)	box quantity
45270	000	14		160 x 105	20 *



**Rubber curry comb, large**

article no.	qualities available			measures (mm)	box quantity
45272	000	71		165 x 110	20



**Rubber curry comb for children**

article no.	qualities available			measures (mm)	box quantity
45272	001	71		130 x 80	20

**Powerful revolving leather punch, 70% less power needed**  
 Made in Germany – Top Quality

article no.	qualities available			box quantity
45259	002	00		5 *



**Revolving leather punch**  
 Made in Germany – Top Quality

article no.	qualities available			box quantity
45259	001	00		5



**Sweat-scraper**  
 rubber on stainless steel blade

article no.	qualities available			box quantity
45277	000	00		10



**Sweat-scraper**  
 brass blade with plastic handles, 80 cm

article no.	qualities available			box quantity
45278	000	00		10







**Fetlock shears, bent**



article no.	000	qualities available		box quantity
45261	000	56		5



**Tail comb, coarse**

article no.	000	qualities available	measures (mm)	box quantity
46024	000	49	210 x 45	20



**Pulling comb, coarse**

article no.	000	qualities available	measures (mm)	box quantity
46030	000	49	90 x 25	20



**Hoof-knife, usable on both sides**



article no.	000	00	length (cm)	box quantity
45264	000	00	20	10



**Ribbed bell boots, first class quality  
soft rubber, easy mounting**

article no.	001	002	003	004	qualities available	measures (mm)	weight per pc.	box quantity
<b>rubber, black</b>								
45294	001			71		70 x 125	110g	5 Pr. *
	002			71		75 x 140	140g	5 Pr. *
	003			71		80 x 140	160g	5 Pr. *
	004			71		85 x 140	210g	5 Pr. *

**Bit guards**

article no.	qualities available				measures (mm)	box quantity
<b>black</b>						
45295	025	71			90 x 25	10 Pr.
<b>white</b>						
45296	025	72			90 x 25	10 Pr.
<b>black for ponies</b>						
45295	020	71			70 x 15	10 Pr.

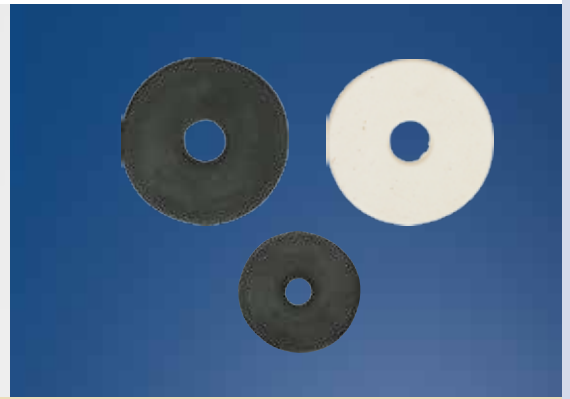

**Lunge rings, black**

article no.	qualities available				measures (mm)	box quantity
45297	085	71			80 x 50	10 Pr.



**Rubber ear cover, light brown**

article no.	qualities available				box quantity
45305	000			75	10 Pr.



**Martingale rings**

article no.	qualities available				inside width (mm)	box quantity
45400	025	71			28,5	100 St.
45400	025			75	28,5	100 St.

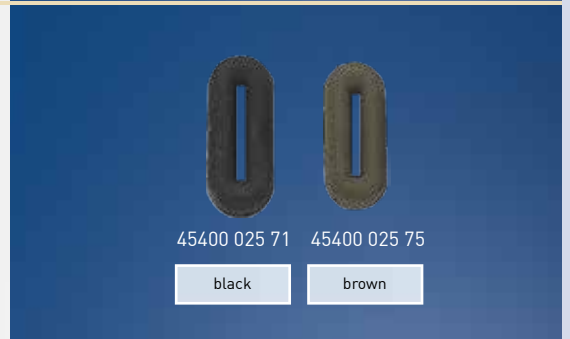

**Martingale loops**

article no.	qualities available				inside width (mm)	box quantity
45401	025	71		74	22,3	100 St.



**Lunge straps, black**

article no.	qualities available				measures (mm)	box quantity
45298	500	71			500	4 Pr.





**Bridle hanger**  
steel lacquered, black

article no.	qualities available			box quantity
46070	001	00		10



**Bridle hanger "Ancre"**  
steel plastic-coated, red

article no.	qualities available			box quantity
46071	000	00		10



**Hanger for blankets**  
steel lacquered, black

article no.	qualities available			size (cm)	box quantity
46138	000	00		90	5



**Saddle rack, swings to both sides**

This saddle rack can be swiveled sideways when not being used. Ideal for the cleaning place, paddock or stable lane. Fixation is possible due to a locking spring.

article no.	qualities available			length (cm)	box quantity
46077	000	06		43	5



**Stable-plate**  
black plastic with white inscription

article no.	qualities available			measures (mm)	box quantity
45510	000	00		30 x 20	5



**Hay net with rings**  
cotton, white

article no.	qualities available			box quantity
49400	000	00		10

**Boot stretchers**

aluminium with steel zinc plat. handle

article no.		box quantity
for ladies up to size 38		
49220	001 00	5 *
for men		
49220	002 00	5 *

**Cavallo boot hooks**steel nickle plated with plastic handle  
length 25,5 cm

- anatomically formed
- no pressure on the calves
- facilitates to slip into the boot

article no.		box quantity
49205	000 01	10 *

**Boot hooks**steel nickle plated with plastic handle  
length 21 cm

article no.		box quantity
49203	000 01	10 *







**“Butler James” – Top quality – Made in Germany**

- less expenditure of energy
- without sharp edges
- footing non slip
- robust piping-construction

article no.	qualities available			box quantity
<b>for ladies up to size 40</b>				
49218	001	14		1 *
<b>for men</b>				
49218	002	14		1 *



**Boot jack**  
plastic, very sturdy

article no.	qualities available			box quantity
49209	000	00		10



**Boot jack**  
wood varnished, solid stands

article no.	qualities available			box quantity
49210	000	00		10



**Boot jack**  
wood varnished, folding stands

article no.	qualities available			box quantity
49211	000	00		10



**Metal boot jack, blue**  
folding stand  
with movable cheeks adapting to boot heel

article no.	qualities available			box quantity
49215	000	00		10



# SELLING AIDS

## SPRENGER quality

By using the finest raw materials which are subjected to rigorous final inspections, we guarantee high-quality standards for our products. This ensures items of distinction for both horse and rider. Selling aids provide appropriate presentations for our leading products.

Selling aids.....	99-102
5.1 TEGO System.....	100
5.2 Sales Center / Test Center.....	101
5.3 Accessories.....	102

# 5.0



49104 ... 00

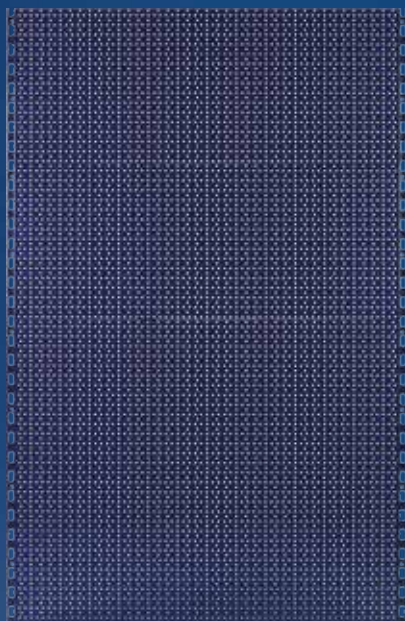

49105 ... 00

### TEGO Shop fitting system

The TEGO shop-fitting system offers a variety of opportunities to be able to present your individual product range in a modern way. It optimises the way you can present and promote your own assortment of products and the extendable shelf system offers unlimited functionality.

The picture shows 2 basic models displaying SPRENGER products.

Further versions supplements and accessories on request.



article no.	qualities available		box quantity
<b>TEGO System perforated panel</b>			
W 104 cm x H 173 cm x D 55 cm			
49104	000	00	freestanding without rollers 1
	001	00	freestanding with rollers, 2 with stopper 1
	002	00	drawer W 99 cm x H 10 cm x D 48 cm 1
<b>TEGO System for wall installation</b>			
49105	000	00	W 100 cm x H 160 cm x D 3,5 cm 1
<b>Optional accessory:</b>			
49103	001	00	leaflet rack DIN A6 high size 1 pc.
	002	00	shelf 20 x 10 cm blue (e.g. for stirrups) 1 pc.
	003	00	1 set = 25 short hooks for perforated panel, 4 x 105 mm 1 Set
	004	00	1 set = 25 long hooks for perforated panel, 4 x 160 mm 1 Set
	005	00	1 set = 5 hooks for perforated panel for Weymouth bits (cutted) 1 Set
	006	00	1 set = 50 product clips for the hooks 1 Set
	007	00	1 set = 50 anti-theft device for the hooks 1 Set
	008	00	1 set = 10 safety clamps for loose ring snaffles 1 Set
	010	00	1 set = 2 lamps Halogen, 220V, 50W, pivotable 1 Set



**Premium Riding Equipment sales center**  
(trapez perforated panel), steel – colour: blue

The trapez form enables you to present a large variety of products while saving space at the same time. Adjust this premium sales stand for your own assortment of products with its flexible display options. Lockable storage place in the rear part.

On two sides this stand offers space for a maximum of approx.:  
80-100 Loose ring snaffles and Pelhams  
20 Weymouth bits  
40 pairs of spurs

article no.	qualities available			box quantity	
49106	000	00		sales center H 198 x W 63 x D 48 cm	1 pc.
49103	001	00		leaflet rack DIN A6 high size	1 pc.
	002	00		shelf 20 x 10 cm blue (e.g. for stirrups)	1 pc.
	003	00		1 set = 25 short hooks for perforated panel, 4 x 105 mm	1 Set
	004	00		1 set = 25 long hooks for perforated panel, 4 x 160 mm	1 Set
	005	00		1 set = 5 hooks for perforated panel for Weymouth bits (cutted)	1 Set
	006	00		1 set = 50 product clips for the hooks	1 Set
	007	00		1 set = 50 anti-theft device for the hooks	1 Set
	008	00		1 set = 10 safety clamps for loose ring snaffles	1 Set
	010	00		1 set = 2 lamps Halogen, 220V, 50W, pivotable	1 Set
	011	00		1 set = 4 heavy weight rollers, 2 with stopper	1 Set

**Sales stand**  
for 60 pairs of spurs

article no.	qualities available			box quantity	
49121	000	00		height: 80 cm, Ø 40 cm	1

**SPRENGER Test Center**

Consisting of:

- perforated panel with stainless steel frame, measures W 90 x H 94 cm
- 14 hooks
- 1 acrylic leaflet rack A4
- 1 acrylic leaflet rack A6 high size
- Choice of bits (to be ordered separately)

This sales display has to be equipped with a variety of different SPRENGER bits that you can lend to your customers for testing. Please discuss the specific details and displays with our sales team.

article no.	qualities available			box quantity
49123	000	00		1 *



49106 000 00



49121 000 00







**Diamond Paste (1 set = 6 tubes 100 ml)**

SPRENGER Diamond Paste cleans, maintains and puts the sparkle back into your Sprenger bits, spurs, stirrups and harness fittings. SPRENGER Diamond Paste is kind to the skin and non toxic. Contains micro fine polishing granules. <5% anionic and non ionic tensides fragrance free.

article no.	qualities available			box quantity
45256	150	00		1 Set *



**Wither gauge**

selling aid for saddles, including instruction leaflet

article no.	qualities available			box quantity
46505	000		33	1



**Bit measure, stainless steel**

The correct bit size for contented horses

article no.	qualities available			box quantity
49102	000	00		1 *



**Display ring**

article no.	size (mm)	qualities available		measures (mm)	measures (inch)	box quantity
46000	060	06		60	2.1/2	50
	090	06		90	3.1/2	50
	120	06		120	4.3/4	50
<b>with hanger</b>						
46001	120	06		120	4.3/4	50





# HARNESS FITTINGS AND INDEX

## Driving with enthusiasm:

Beautifully designed Harness Fittings made of carefully chosen materials to withstand the extremes encountered in driving sports.

Our range contains buckles, metal fittings and saddle parts which have been used for decades by leading saddle makers. It is attention to detail that makes the difference.

SPRENGER Harness Fittings make a perfect team.







Georg von Stein  
 (Team silver medal winner at:  
 European Championships 2015  
 and World Championships 2014)

Harness fittings and Index.....	104-128
6.1 Harness fittings.....	106-111
6.2 Saddle accessories.....	112
6.3 Stirrup leather and girth buckles.....	113
6.4 Rings and terrets.....	114-115
6.5 Harness accessories.....	116
6.6 Blanket accessories.....	117
6.7 Rosettes, Chain fronts, bosses and horse brasses.....	118-119
6.8 Hames and sleigh bells.....	120
6.9 Hooks for Marathon.....	121
6.10 Snap and panic hooks.....	122-123
6.11 Lead and safety chains.....	124
6.12 Gift articles.....	125
6.13 Index.....	126-128

#### QUALITIES AVAILABLE

00	miscellaneous
01	steel nickel plated
04	steel brass plated
05	steel polished
06	steel galvanized
30	brass polished, I. quality
31	brass polished, I. quality nickel plated
32	brass polished, I. quality chrome plated
33	brass polished, II. quality
34	brass polished, II. quality nickel plated
35	brass polished, II. quality chrome plated
39	neverrust zinc plated
40	German Silver highly polished
43	German Silver mechanically polished
45	highly polished
50	neverrust brass plated
51	aluminium waterproof
55	HS-stainless steel
56	stainless steel

#### PLEASE NOTE

Quality keys and dimensions can also be found on the last page of this catalogue.





40706 100 01

**Cheek Bar with "S"-hook, casted**

article no.	size (mm)	qualities available			inside width (mm)	box quantity
40706	100	01			100	20



43219 020 43

43220 ... 43

43223 ... 43



46681 ... 43

46687 020 55

49520 ... 01

**D-Ring**

article no.	size (mm)	qualities available			inside width (mm)	box quantity
<b>casted</b>						
43219	020			43	20 (x3)	100
43220	0..			43	20 (x4,5) 23 (x4,5) 25 (x4,5) 27 (x4,5) 29 (x4,5) 32 (x4,5)	100
43223	0..			43	16 (x3) 20 (x3) 23 (x3)	100
46681	0..			43	16 (x3) 20 (x3)	100
<b>punched</b>						
46687	020			55	20 (x2,7)	100
<b>welded</b>						
49520	0..	01			20 (x3,0) 25 (x3,4)	1000



46780 018 40

46670 001 55

**Loop, casted**

article no.	size (mm)	qualities available			inside width (mm)	box quantity
46780	018			40	18 (x2,2)	50

**Buckle for reins, casted**

article no.	qualities available			inside width (mm)	box quantity	
46670	001			55	24	50



43227 ... 43

43231 ... 33

43231 040 34

**Martingale ring, casted**

article no.	size (mm)	qualities available			inside width (mm)	box quantity
43227	0..			43	25 (x4) 30 (x4) 35 (x5)	50
43231	0..			33	25 (x4,5) 30 (x4,8) 35 (x5,5) 40 (x5,5) 50 (x7)	50
43231	040			34	40 (x5,5)	50



49526 ... 01

49526 040 04

49526 055 56

**Ring, welded**

article no.	size (mm)	qualities available			inside width (mm)	box quantity
49526	0..	01			20 (x3,5) 30 (x4,5) 36 (x5,3)	1000
	040		04		40 (x6,0)	1000
	055			56	55 (x6)	50

**Bridle buckle, punched, high strength**

article no.	size (mm)	qualities available	inside width (mm)	box quantity
46694	0..	43	10 13 16 18 20 23 25	50
46695	0..	33	13 16 18 20 23	50
	0..	55	10 13 16 18 20 23 25	25



**Bridle buckle, casted**

article no.	size (mm)	qualities available	inside width (mm)	box quantity
46680	0..	33	13 16	100
	0..	43	13 16 18 20 23 25 29	100
46690	0..	33	13 16	100
	0..	43	13 16 18 20	100



**Buckle with roller, casted**

article no.	size (mm)	qualities available	inside width (mm)	box quantity
46530	016	33	16	100
	0..	43	13 16 18 20 25	100



**Buckle with roller, welded, round and very strong**

article no.	size (mm)	qualities available	inside width (mm)	box quantity
49512	0..	01	18 20 26 30	1000

**Bridle buckle, casted**

article no.	size (mm)	qualities available	inside width (mm)	box quantity
46760	0..	43	13 16 18 20 23 25	100
43580	020	43	20	50



**Buckle**

article no.	size (mm)	qualities available	inside width (mm)	box quantity
46238	0..	30	20 25 27 29	20
	0..	40	20 25 27 29	20
46239	0..	30	25 29	20



**Buckle for spur straps**

article no.	size (mm)	qualities available	inside width (mm)	box quantity
46160	014	40	14	100
46161	0..	01	14 16	100
	0..	43	14 16	100

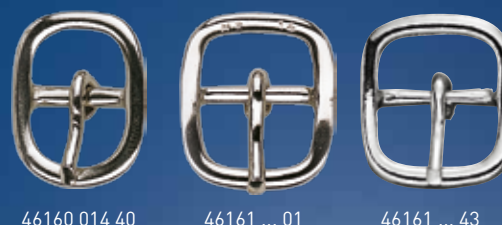



46960



46965 ... 33

46965 ... 43

**Hook stud**

article no.	qualities available			inside width (mm)	box quantity
<b>Hook stud</b>					
46960	000		43	8 x 18	100
<b>Hook stud for rounded bridles</b>					
46965	000	33	43	5 x 18	100



46860

46870 ... 43

**Noseband ring**

article no.	size (mm)	qualities available			inside width (mm)	box quantity
46860	025			43	25	50
46870	0..			43	16 23	100



46242

46244



46245

46243

**Halter square**

article no.	size (mm)	qualities available			inside width (mm)	box quantity
<b>heavy</b>						
46242	036			34	36 x 40	50
46244	025			34	25	50
46245	025		33		25	50
<b>punched</b>						
46243	025	01			25	100



46255 ... 33

46255 ... 34

**Toggle for halters, heavy**

article no.	size (mm)	qualities available			inside width (mm)	box quantity
46255	025	33	34		25	50

**Buckle, round**

article no.	size (mm)	qualities available	inside width (mm)	box quantity
43560	0..	33	12 14 16 18 20	50
			23 25 32	50
43560	0..	43	10 12 14 16 18 20	50
			23 25 27 29 32	50
43560	0..	56	10 12 14 16 18 20	50
			23 25 27 29	50



43560 ... 33

43560 ... 43

43560 ... 56

**Double buckle**

article no.	size (mm)	qualities available	inside width (mm)	box quantity
<b>Double buckle with roller, small</b>				
43585	012	34	12	100
<b>Double buckle without roller, small</b>				
43586	012	55	12	100

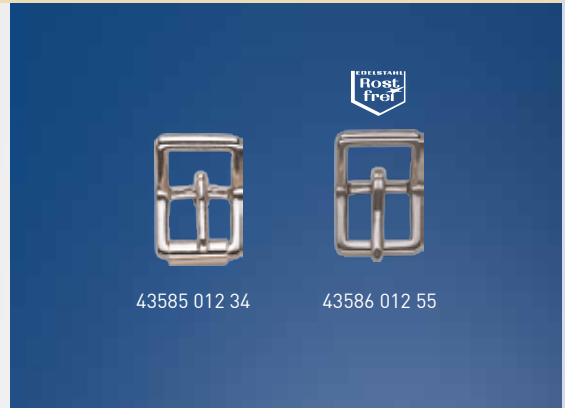

43585 012 34

43586 012 55

**Double buckle**

article no.	size (mm)	qualities available	inside width (mm)	box quantity
<b>Double buckle with roller</b>				
43590	025	56	25	50
<b>Double buckle, casted</b>				
49504	0..	45	16 20 25	1000



43590 025 56

49504 ... 45

**Buckle with fork tongue**

article no.	size (mm)	qualities available	inside width (mm)	box quantity
43599	045	43	45	50



**Lungeing cavesson iron with 3 rings**  
(body: brass nickel plated / rings: steel nickel plated)

article no.	size (mm)	qualities available	box quantity
45600	000	01	5

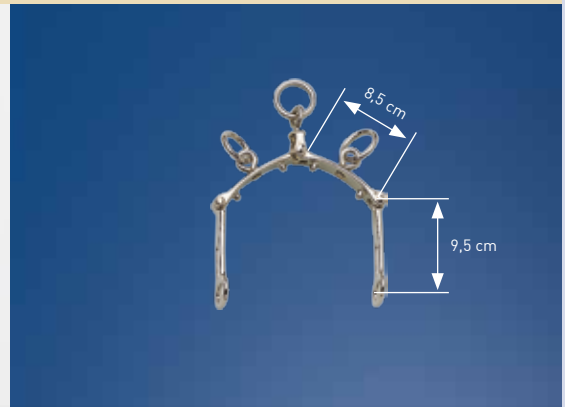



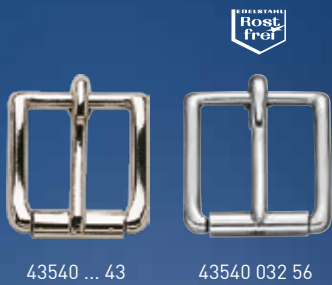

**Buckle**

article no.	size (mm)	qualities available		inside width (mm)	box quantity
43540	0..		43	18 20 23 25 27 29 32	50
	032		56	32	50



**Buckle**

article no.	size (mm)	qualities available		inside width (mm)	box quantity
43850	025		43	25	20



**Buckle**

article no.	size (mm)	qualities available		inside width (mm)	box quantity
<b>inside height 45 mm</b>					
43860	022		56	22	50
<b>inside height 38 mm</b>					
43861	022		43	22	20



**Buckle**  
inside height 82 mm

article no.	size (mm)	qualities available		inside width (mm)	box quantity
43480	036		56	36	10



43535 ... 31

**Buckle**

article no.	size (mm)	qualities available		inside width (mm)	box quantity
43535	0..		31	60 70	10

French tug



article no.	size (mm)	qualities available		inside width (mm)	box quantity
43515	033	55		33	5



Rein slide



article no.	size (mm)	qualities available		inside width (mm)	box quantity
43841	025	55		25	50



Breechen dee



article no.	size (mm)	qualities available		inside width (mm)	box quantity
43630	023	43		23	100
	025		56	25	100



43630 023 43



43630 025 56

Trace square



article no.	size (mm)	qualities available		inside width (mm)	box quantity
43605	0..	43		30 36	10
	036		56	36	20



43605 ... 43



43605 036 56

Ring



article no.	size (mm)	qualities available		inside width (mm)	box quantity
43600	036		56	36	20





### Gullet plate HS Standard

Forged special steel, hardened and tempered.  
Special production of numerous other types available subject to reasonable minimum order quantities.

article no.	qualities available		box quantity
45231	001	05	inside width 28,6 cm 1



### Stirrup bars



Special production with special shape, drillings and length on demand.

article no.	qualities available		length (cm)	box quantity
<b>Stirrup bars with metal knob</b>				
45237	000		55 9	10
<b>Stirrup bars dressage with metal knob</b>				
45237	011		55 12,5	10



### Saddle nail

Special production with your company logo on demand possible.

article no.	qualities available		head-Ø (mm)	box quantity
46900	009		40 55 9	100
	011		40 55 11	100
	013		40 55 13	100



### Fall down staple

article no.	size (mm)	qualities available		inside width (mm)	length (mm)	box quantity
<b>Fall down staple, high quality punched</b>						
46930	021	43	55	21	26	50
<b>Fall down staple</b>						
46931	021	33	43	21	40	50
46934	021		43	21	38	50



### Staple

article no.	size (mm)	qualities available		inside width (mm)	box quantity
49565	0..	33		20 26 30 = L 1 40 50 56 = L 2	20
49565	0..		35	20 26 30 36 40 = L 1 40 50 56 65 70 = L 2	20

Stirrup leather buckle

article no.	size (mm)	qualities available	inside width (mm)	box quantity
46230	023		56	23
	925		55	25
	027	01	55	27
	029	01	55	29



Stirrup leather buckle with roller

article no.	size (mm)	qualities available	inside width (mm)	box quantity
46230	025	34	25	50
46228	0..		27 29	50



Girth buckle with roller

article no.	size (mm)	qualities available	inside width (mm)	box quantity
46233	027	01	55	27
	029	01	55	29



Girth buckle with fixed roller

article no.	size (mm)	qualities available	inside width (mm)	box quantity
46234	027		55	27
	029	01	55	29



Double buckle with roller

article no.	size (mm)	qualities available	inside width (mm)	box quantity
46219	025		56	25
	029	01	56	29

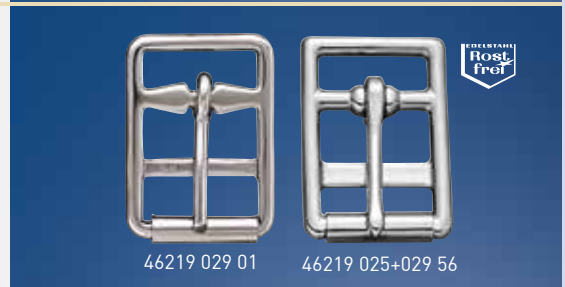

Buckle with roller

article no.	size (mm)	qualities available	inside width (mm)	box quantity
46261	040		43	28 x 40
	052		43	28 x 52







43465 000 30

43465 000 40 (56)  
43467 000 40

43464 000 56

Neck strap ring

article no.	qualities available			inside width (mm)	box quantity
<b>movable for ponies</b>					
43467	000		40	38	10
<b>movable - standard</b>					
43465	000	30	40 56	40	10
<b>movable - large</b>					
43464	000		56	50	10



Neck strap ring  
rigid, eye size: 26 x 8 mm



article no.	qualities available			inside width (mm)	box quantity
43460	000		56	38	10



Ring

article no.	qualities available			inside width (mm)	box quantity
<b>for 2 horses</b>					
43450	001		40	42	10



43385 000 30

43387 000 40

Ring

article no.	qualities available			inside width (mm)	box quantity
<b>"horseshoe"</b>					
43385	000	30		49	10
<b>"acorn"</b>					
43387	000		40	47	10

Terret, casted with threaded plate

article no.	size (mm)	qualities available			inside width (mm)	thread		box quantity
						Ø (mm)	length (mm)	
43300	045		40		45 x 7,0	10	28	10
	045		56		45 x 7,0	10	24	



43300 045 40

43300 045 56

Terret for ponies and trotters

article no.	size (mm)	qualities available			inside width (mm)	thread		box quantity
						Ø (mm)	length (mm)	
<b>Terret for trotters</b>								
43800	028		43		28 x 5,0	10	20	10
43802	035		56		35 x 5,3	10	24	10



43800 028 43

43802 035 56

Terret with threaded plate

article no.	qualities available			inside width (mm)	thread		box quantity	
					Ø (mm)	length (mm)		
43317	001		40		50	10	28	10

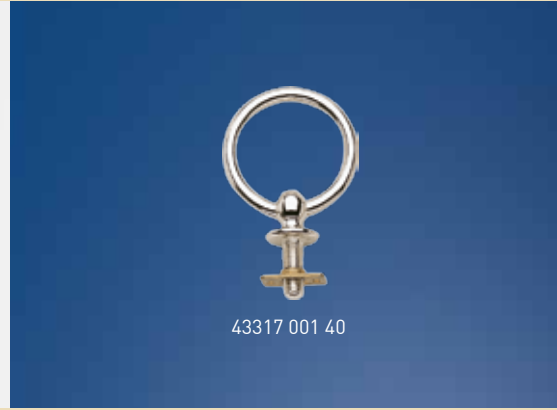

43317 001 40

Pad hook with nut suitable for 43300

article no.	qualities available			inside width (mm)	thread		box quantity	
					Ø (mm)	length (mm)		
43320	000	30	40	56	32	10	18	10



43320 000 30

43320 000 40

43320 000 56

Pad hook and ring

article no.	qualities available			inside width (mm)	thread		box quantity	
					Ø (mm)	length (mm)		
<b>Pad hook with nut for 4 horses</b>								
43337	002		40		50	10	18	10
<b>Ring with threaded plate</b>								
43380	032		56		29	10	27	10



43337 002 40

43380 032 56



**Crupper loop, movable**



article no.	size (mm)	qualities available			inside width (mm)	box quantity
43415	030			56	30	20

**Screw 10 mm with threaded plate**



43395 035 43

43420 033 40

article no.	size (mm)	qualities available			thread length (mm)	box quantity
43395	035		43		35	10

**Staple with nuts 6 mm**

article no.	size (mm)	qualities available			inside width (mm)	thread length (mm)	box quantity
43420	033		40		33	25	20

**Sellett saddle**



article no.	qualities available			box quantity
43403	000		51	10

**Toe weight**



43890 ... 33

43891

43892

article no.	qualities available			weight	box quantity
43890	002	33		2 ounces	5
	003	33		3 ounces	5
	004	33		4 ounces	5

**Accessories for toe weight 43890**

article no.	qualities available			box quantity
<b>support</b>				
43891	000	33		50
<b>screw</b>				
43892	000	33		50

**Buckle**

article no.	size (mm)	qualities available	inside width (mm)	box quantity
49550	050	01	50	50



**HS Surcingle attachment, clasp**

article no.	qualities available	inside width (mm)	box quantity
49552	000 01	50	25
23228		male	
23227		female	

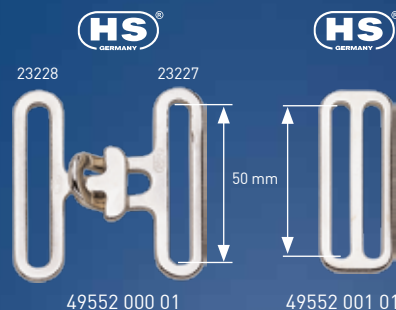

**HS Surcingle attachment, slide**

article no.	qualities available	inside width (mm)	box quantity
49552	001 01	50	25

**HS Surcingle attachment, clasp (cutted) suitable for exchange**

article no.	qualities available	inside width (mm)	box quantity
49553	000 01	50	25
23278		male	
23279		female	

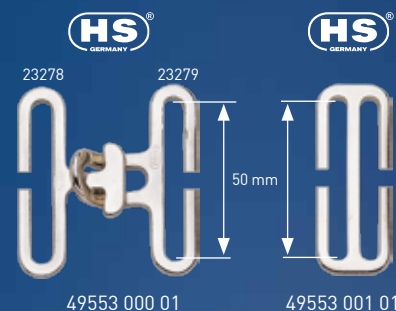

**HS Surcingle attachment, slide (cutted) suitable for exchange**

article no.	qualities available	inside width (mm)	box quantity
49553	001 01	50	25

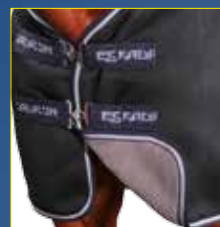

**Buckle for blankets with double bar and fixed tongue**

article no.	size (mm)	qualities available	inside width (mm)	box quantity
46766	027	01	27	50



**Snap hook for blankets, length: 62 mm**

article no.	qualities available	inside width (mm)	box quantity
48210	062 01	27	50







49280 050 30



49280 ... 31



### Little vessel

article no.	length (mm)	qualities available			length (mm)	box quantity
49280	050	30			50	50
	0..		31		50 70	50



### Boss – head Ø 20 mm

article no.	size (mm)	qualities available			box quantity
49560	020	30			50



### Chain front, 21 casted links

article no.	size (mm)	qualities available			length (cm)	box quantity
43662	000		40		41	5



43665 ... 40

### Chain front

article no.	size (mm)	qualities available			length (cm)	box quantity
43665	0..		40		36 38	5



### Browband stripe

article no.	size (mm)	qualities available			length (cm)	box quantity
43666	000	30			33 x 1,8	10

Horse brass with horse head, punched

article no.	qualities available				inside width (mm)	eye size (mm)	box quantity
<b>left</b>							
49268	001	30	31		75	23	20
<b>right</b>							
49268	002	30	31		75	23	20



Rosette with horse head, punched

article no.	qualities available				inside width (mm)	eye size (mm)	box quantity
<b>left</b>							
43675	001	30	31		55	26	10
<b>right</b>							
43675	002	30	31		55	26	10



Rosette, flat

article no.	size (mm)	qualities available				inside width (mm)	eye size (mm)	box quantity
43670	045		31			45	20 x 15	10



Rosette, slightly curved

article no.	size (mm)	qualities available				inside width (mm)	eye size (mm)	box quantity
43672	060	30	31			60	26 x 15	10



Horse brass

article no.	size (mm)	qualities available				inside width (mm)	box quantity
49275	0..	30				26 35 40 45 70	100
	0..		31			26 35 40 45 60	100

article no.	size (mm)	qualities available				inside width (mm)	box quantity
49263	080			40		80	10





**Hame with rings**

SPRENGER hames are produced according to an approved standard form. Special versions – e.g. angle of curve, alternative loop positions or different lengths (48 to 62 cm) – are all possible at extra cost.



article no.	qualities available	length	box quantity	
43680	056	55	56 cm	2
	058	55	58 cm	2
<b>Oval ring for hame</b>				
43684	100	55	100 mm	10
<b>Round ring for hame</b>				
43685	045	55	45 mm Ø	10



**Hame clips (per pair)**



article no.	qualities available	box quantity	
43690	000	55	1



**Rivet for 43690**

article no.	qualities available	box quantity	
43692	000	55	100



**Sleigh bells, without feather tufts**

article no.	qualities available	box quantity	
46710	000 30		1
	000 31		1



**Feather case with threaded plate 10 mm**

article no.	qualities available	length (mm)	box quantity	
46700	060	31	60	1

**Sleigh bell**

article no.	qualities available	diameter (mm)	box quantity	
46709	0..	40	28 32 35 39 50	10

**Hook for Marathon (forged) – TOP Quality**  
with security pin



article no.		qualities available	width (mm)	length (mm)	box quantity
43608	120	55	20	130	1



← with splint

**HS-Hook for Marathon (casted)**  
with security pin



article no.		qualities available	width (mm)	length (mm)	box quantity
43607	990	56	13	90	10
	920	56	20	130	10



← with splint

**HS-Hook for Marathon (casted)**  
with security pin



article no.		qualities available	width (mm)	length (mm)	box quantity
43607	090	56	13	90	10
	120	56	20	130	10



← with screw

**HS-Hook for Marathon (casted)**



article no.	width (mm)	qualities available	width (mm)	length (mm)	box quantity
43607	036	56	36	90	10
	045	56	45	130	10



43607 036 56

43607 045 56

← with screw

**Hook for Marathon with swivel (casted)**  
with security pin



article no.		qualities available	width (mm)	length (mm)	box quantity
43609	120	56	22	125	10



**Buckle “Van der Wiel”**



article no.	size (mm)	qualities available	width (mm)	length (mm)	box quantity
43616	036	56	36	160	1







48300 ... 06

48300 ... 55

48310 080 06

Snap hook

article no.	qualities available		length (mm)	box quantity
<b>Snap hook</b>				
48300	0..	06	55 60 70 80 100	20
<b>Snap hook with screw lock</b>				
48310	080	06	80	20

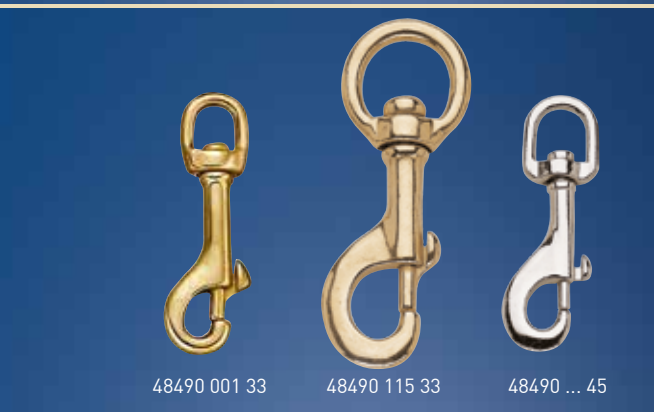

48490 001 33

48490 115 33

48490 ... 45

Snap hook

article no.	qualities available		length (mm)	eye size (mm)	box quantity
48490	001	33	78	13	20
48490	115	33	116	30	20
48490	075	45	78	14	20
	080	45	80	17	20
	085	45	84	20	20



48505 ... 45

48505 ... 50

48508 016 45

Snap hook

article no.	qualities available		length (mm)	eye size (mm)	box quantity
48505	022	45 50	82	23	20
	025	45 50	82	26	20
48508	016	45	85	18	20



48200 020 33

48200 020 45

48200 055 45

Snap hook

article no.	qualities available		length (mm)	eye size (mm)	box quantity
48200	020	33 45	63	21	20
	055	45	67	19	20



48460 090 33

48210 062 01

Snap hook

article no.	qualities available		length (mm)	eye size (mm)	box quantity
<b>Snap hook</b>					
48460	090	33	87	16	20
<b>Snap hook for blankets</b>					
48210	062	01	62	27	50

**Panic hook**

article no.	qualities available			length (mm)	box quantity
48465	000		39	104	20
	000		50	104	20



48465 000 39

48465 000 50

**Snap hook**

article no.	qualities available			length (mm)	eye size (mm)	box quantity
48493	016		33	63	17	20
	016		34	63	17	20
48493	022	00		67	22	20
	022		34	67	22	20
48550	016		45	43	17	20

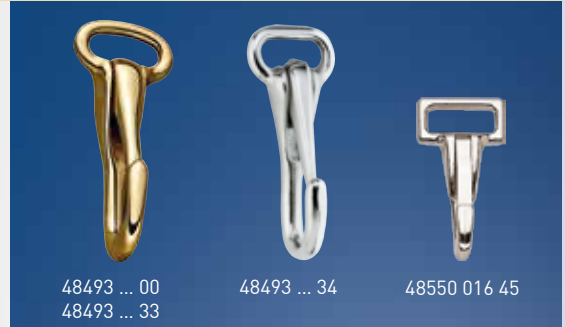

48493 ... 00  
48493 ... 33

48493 ... 34

48550 016 45

**Snap hook**

article no.	qualities available			length (mm)	eye size (mm)	box quantity
48520	022		45	59	23	20
	025		45	60	27	20
48440	025		39	75	26	20
48445	025		45	87	26	20



48520 ... 45

48440 025 39

48445 025 45

**Lunge hook**

article no.	qualities available			length (mm)	eye size (mm)	box quantity
48290	000	01		101	45	10

**Block for lungees for 8 mm ropes**  
suitable snap hook 48490 085 45 (see p.122)



article no.	qualities available			length (mm)	box quantity
45000	000		55	57	10



48290 000 01

45000 000 55

**Swivel**

article no.	size (mm)	qualities available			width (mm)	box quantity
<b>Lunge swivel</b>						
45299	023		34		23	50
<b>Swivel, small</b>						
45300	014		43		14	50



45299 023 34

45300 014 43



Lead chain

article no.	qualities available			length (cm)	eye size (mm)	box quantity
46050	045	06		45	27	5
46050	055	06		55	27	5
46050	075	01		75	27	5
46053	055		55	55	25	5
	075		55	75	25	5



Safety chain

article no.	qualities available			length (cm)	box quantity
46052	070	06		70	5

Safety chain with plastic cover

article no.	qualities available			length (cm)	box quantity
46055	070	06		70	10
	140	06		140	10

Coat hanger, small

article no.		qualities available		length (cm)	box quantity
49631	001	30		10,5	1



Coat hanger, large

article no.		qualities available		length (cm)	box quantity
49634	000	30		14,5	1



Horse shoe incl. assembling set

article no.		qualities available		length (cm)	box quantity
49680	000	32		12,5 x 13	1



Horse shoe with brand incl. assembling set

article no.		qualities available		measures (cm)	box quantity
49685	004	32		Hannover 11 x 10,5	1
	008	32		Bayern 11 x 10,5	1
	015	32		Haflinger 11 x 10,5	1
	016	32		Mecklenburg 11 x 10,5	1
	017	32		Sachsen 11 x 10,5	1



004



008



015



016



017





article	quality	page	article	quality	page	article	quality	page	article	quality	page	article	quality	page					
43600	...	56	111	45076	...	55	60	46161	...	01	107	47078	...	40	83	48550	...	45	123
43605	...	43	111	45231	...	05	112	46161	...	43	107	47079	...	40	82	49102	...	00	102
43605	...	56	111	45237	...	55	112	46219	...	01	113	47115	...	44	84	49103	...	00	100+101
43607	...	56	121	45249	...	71	41+60	46219	...	56	113	47120	...	40	83	49104	...	00	100
43608	...	55	121	45250	...	71	41+60	46228	...	55	113	47122	...	44	84	49105	...	00	100
43609	...	56	121	45252	...	00	90	46230	...	01	113	47124	...	44	84	49106	...	00	101
43616	...	56	121	45254	...	00	90	46230	...	34	113	47125	...	44	84	49121	...	00	101
43630	...	43	111	45256	...	00	102	46230	...	55	113	47135	...	44	84	49123	...	00	101
43630	...	56	111	45259	...	00	93	46230	...	56	113	47170	...	40	82	49184	...	00	85
43662	...	40	118	45261	...	01	91	46233	...	01	113	47179	...	40	82	49186	...	00	85
43665	...	40	118	45261	...	56	94	46233	...	55	113	47405	...	55	78	49186	...	61	81+85
43666	...	30	118	45263	...	00	92	46234	...	01	113	47415	...	55	78	49188	...	00	85
43670	...	31	119	45264	...	00	94	46234	...	55	113	47421	...	55	78	49189	...	00	41+85
43672	...	30	119	45267	...	01	90	46238	...	30	107	47425	...	55	78	49189	...	04	85
43672	...	31	119	45270	...	14	92	46238	...	40	107	47425	...	61	79	49189	...	61	81+85
43675	...	30	119	45271	...	14	92	46239	...	30	107	47425	...	62	79	49190	...	71	85
43675	...	31	119	45272	...	71	92	46242	...	34	108	47427	...	55	78	49203	...	01	97
43680	...	55	120	45275	...	00	90	46243	...	01	108	47431	...	55	78	49205	...	01	97
43684	...	55	120	45277	...	00	93	46244	...	34	108	47435	...	55	78	49209	...	00	98
43685	...	55	120	45278	...	00	93	46245	...	33	108	47440	...	55	78	49210	...	00	98
43690	...	55	120	45280	...	00	89	46255	...	33	108	47451	...	55	79	49211	...	00	98
43692	...	55	120	45281	...	00	91	46255	...	34	108	47452	...	55	79	49215	...	00	98
43800	...	43	115	45283	...	00	89	46261	...	43	113	47458	...	55	79	49218	...	14	98
43802	...	56	115	45284	...	00	89	46505	...	33	102	47461	...	55	79	49220	...	00	97
43841	...	55	111	45285	...	00	91	46530	...	33	107	47462	...	55	79	49263	...	40	119
43850	...	43	110	45286	...	00	89	46530	...	43	107	47515	...	55	80	49268	...	30	119
43860	...	56	110	45287	...	00	90	46670	...	55	106	47515	...	61	81	49268	...	31	119
43861	...	43	110	45288	...	00	88	46680	...	33	107	47521	...	55	80	49275	...	30	119
43890	...	33	116	45289	...	00	88	46680	...	43	107	47521	...	61	81	49275	...	31	119
43891	...	33	116	45294	...	71	94	46681	...	43	106	47525	...	55	80	49280	...	30	118
43892	...	33	116	45295	...	71	95	46687	...	55	106	47525	...	61	81	49280	...	31	118
44140	...	00	71	45296	...	72	95	46690	...	33	107	47531	...	55	80	49400	...	00	96
44140	...	56	71	45297	...	71	95	46690	...	43	107	47535	...	55	80	49504	...	45	109
44224	...	56	74	45298	...	71	95	46694	...	43	107	47535	...	61	81	49512	...	01	107
44234	...	55	73	45299	...	34	123	46695	...	33	107	47551	...	55	80	49520	...	01	106
44235	...	71	75	45300	...	43	123	46695	...	55	107	47552	...	55	80	49526	...	01	106
44236	...	55	73	45305	...	75	95	46700	...	31	120	47561	...	55	80	49526	...	04	106
44240	...	71	73	45311	...	00	88	46709	...	40	120	47562	...	55	80	49526	...	56	106
44242	...	56	73+75	45400	...	71	95	46710	...	30	120	48043	...	40	83	49550	...	01	117
44242	...	71	75	45400	...	75	95	46710	...	31	120	48200	...	33	122	49552	...	01	117
44242	...	72	75	45401	...	71	95	46760	...	43	107	48200	...	45	122	49553	...	01	117
44244	...	56	74	45401	...	74	95	46766	...	01	117	48210	...	01	117+122	49560	...	30	118
44245	...	88	74	45406	...	56	91	46780	...	40	106	48290	...	01	123	49565	...	33	112
44249	...	56	74	45420	...	00	91	46860	...	43	108	48300	...	06	122	49565	...	35	112
44250	...	56	75	45510	...	00	96	46870	...	43	108	48300	...	55	122	49631	...	30	125
44251	...	00	75	45600	...	01	109	46900	...	40	112	48310	...	06	122	49634	...	30	125
44252	...	00	75	46000	...	06	102	46900	...	55	112	48440	...	39	123	49680	...	32	125
44256	...	56	75	46001	...	06	102	46930	...	43	112	48445	...	45	123	49685	...	32	125
44266	...	55	71	46024	...	49	94	46930	...	55	112	48460	...	33	122				
44266	...	61	71	46030	...	49	94	46931	...	33	112	48465	...	39	123				
44266	...	62	71	46050	...	01	124	46931	...	43	112	48465	...	50	123				
45000	...	55	123	46050	...	06	124	46934	...	43	112	48490	...	33	122				
45050	...	55	60	46052	...	06	124	46960	...	43	108	48490	...	45	122				
45053	...	56	60	46053	...	55	124	46965	...	33	108	48493	...	00	123				
45054	...	02	50	46055	...	06	124	46965	...	43	108	48493	...	33	123				
45055	...	55	60	46070	...	00	96	47022	...	44	84	48493	...	34	123				
45055	...	88	60	46071	...	00	96	47025	...	44	84	48505	...	45	122				
45065	...	55	60	46077	...	06	96	47035	...	44	84	48505	...	50	122				
45071	...	55	60	46138	...	00	96	47070	...	40	82	48508	...	45	122				
45071	...	88	60	46160	...	40	107	47075	...	40	82	48520	...	45	123				

- A**
- 2-TYPE snaffles 13, 33, 64
  - 3-TYPE snaffles 48, 64
  - AURIGAN 10
- B**
- Balkenhol spurs 82
  - Baucher bit 14
  - Bell boots 94
  - Bells 120
  - Bits 6-67
  - Bit guards 95
  - Bit measure 102
  - Blanket accessories 117
  - Block for lunges 123
  - Boot hooks 97
  - Boot jacks 98
  - Boot stretchers 97
  - Bow Balance Stirrups 70-71
  - Bosses 118
  - Bradoons 61-63
  - Breechen dee 111
  - Bridle buckles 107, 109
  - Bridle hangers 96
  - B-Ring snaffle 14
  - Brushes 88-89, 91
  - Buckles 107-117
  - Buckles for reins 106-111
- C/D**
- Carbon bits 37
  - Chain fronts 118
  - Chains 124
  - Cheek bars 106
  - Coat hangers 125
  - Copper Plus bits 64
  - Correction bit 31
  - Crupper loops 116
  - Curb bits and accessories 52-59
  - Curb chains and accessories 60
  - Curry combs 90, 92
  - Diamond Paste 102
  - Display rings 102
  - Double jointed snaffles 11-28, 35, 39, 46-51, 64
  - D-Ring snaffles 38-39
  - D-Rings 106
  - Driving bits 65-67
  - DUO bits 44
  - Dynamic RS snaffles 16-23
- E/F**
- Ear covers 95
  - Eggbutt bits 36-37, 64
  - Fall down staples 112
  - Feather case 120
  - Fetlock shear 94
  - Flex Control bit 30
  - French link snaffles 51
  - French tug 111
  - Full Cheek snaffles 46-47
- G**
- Gag bits and accessories 14, 22, 37
  - German Silver spurs 82-83
  - Gift articles 125
  - Girth buckles 109
  - Grooming gloves 90
  - Grooming items 86-98
  - Gullet plate 112
- H**
- Hackamores and accessories 50
  - Halter fittings 108
  - Hame clips and accessories 120
  - Hames and accessories 120
  - Hanger for blankets 96
  - Harness accessories 116
  - Harness fittings 104-128
  - Hay nets 96
  - Hoof care 94
  - Hoof knife 94
  - Hoof picks 90
  - Hooks for Marathon 121
  - Hook studs 108
  - Horse brass 119
  - Horse shoes 125
- I/J/K**
- Jointed stirrups 70-73
  - Jumping bits 42-43
  - KK bits 31, 34, 38, 42
  - KK ULTRA bits 11-15
- L**
- Lead chains 124
  - Leather punches 93
  - Little vessels 118
  - Loops 106
  - Loose ring snaffles 19, 29, 34-35, 64
  - Lunge hooks and swivels 123
  - Lungeing cavesson iron 109
- M/N/O**
- Mane care 91
  - Mane combs 94
  - Mane rubber rings 91
  - Martingale rings and loops 95
  - MAX-Control bits 48-49
  - Mullen Mouth snaffles 30-31
  - Multi Joint 51
  - Multi Ring 23
  - Neck strap rings 114
  - Noseband ring 108
  - novocontact bits 26-29
- P/Q**
- Pad hook 115
  - Pads for stirrups 73, 75
  - Panic hooks 123
  - Pelhams and accessories 40-41
- R**
- Rake 92
  - Rein slides 111
  - Rings 106
  - Rosettes 119
  - Rubber bits 45
  - Rubber curry combs 92
  - Rubber bit port 51
  - Rubber lunge accessories 95
- Sch**
- Schooling bit 31
- S**
- Saddle accessories 112-113
  - Saddle nails 112
  - Saddle racks 96
- Safety chain 124
  - Sales centers 100-101
  - Scissors and Shears 91, 94
  - Screw 116
  - Sellett saddle 116
  - Selling aids 99-103
  - SENSOGAN 8-9
  - Sleigh bells 120
  - Snaffles and Weymouths 6-67
  - Snap hooks 122-123
  - Spoon Mouth snaffle 51
  - Special bits 51
  - Spurs and accessories 76-85
  - Spur protectors 85
  - Spur straps 85
  - Spur sales center 101
  - Surcingle, slide and clasp 117
  - Sweat-scrapers 93
  - System-4 Stirrups 72-73
- St**
- Stainless steel spurs 78-81
  - Staples 112
  - Stable-plate 96
  - Stable accessories 96
  - Stirrups and accessories 68-75
  - Stirrup pads 73, 75
  - Stirrup leather buckles 113
  - Stirrup bars 112
- T**
- TEGO system 100
  - Terrets 115
  - Test Center 101
  - Thinning knife 91
  - Thinning scissor 91
  - Toe weight and accessories 116
  - Toggle 106
  - Trace square 111
  - TURNADO bits 32-33
- U**
- ULTRA fit spurs 78-81
  - Universal bits and accessories 42
- V/W**
- Western bit 51
  - Weymouth accessories 60
  - Weymouth bits and accessories 52-60
  - WH ULTRA bits 24-25
  - Wither gauge 102
- X/Y/Z**
- Zinc die cast spurs 84

## WHERE YOU CAN OBTAIN SPRENGER PRODUCTS ABROAD

### Australia / New Zealand



Hannoverian Riding Wear  
102 Calton Road  
P.O. Box 282  
Gawler East 5118  
South Australia  
Tel. +61 (0) 8 85 22 19 66  
Fax +61 (0) 8 85 23 10 33  
hrw@hannoverianridingwear.com

### Belgium / Netherlands / Luxembourg



JRS Janssen Ruitersport  
Kettingdreef 2  
NL - 4841 KD Prinsenbeek  
Tel. +31 (0) 7 65 42 81 00  
Fax +31 (0) 7 65 41 75 14  
info@jrnsport.nl

### Denmark



Scan-Horse A/S  
Langebjerg 29  
P.O. Box 312  
DK - 4000 Roskilde  
Tel. +45 (0) 46 74 04 04  
Fax +45 (0) 46 74 04 02  
s-h@scan-horse.com

### Finland



Helsingin Ratsutarvike OY  
Telakkakatu 4  
SF - 15140 Lahti  
Tel. +358 (0) 2 90 03 92 00  
Fax +358 (0) 2 90 03 92 39  
info@helsinginratsutarvike.fi

### France



Robert Lye Equitation S.A.S.  
Z.A.E. des Longs Sillons  
4 Rue des Longs Sillons / B.P. 175  
F - 77527 Coulommiers Cedex  
Tel. +33 (1) 64 75 68 11  
Fax +33 (1) 64 75 68 12  
info-clients@equestrian.fr

### United Kingdom



Zebra Products Ltd  
38 Manor Industrial Estate  
GB - CH65UY Flint - Flintshire  
Tel. +44 (0) 13 52 76 33 50  
Fax +44 (0) 13 52 73 13 79  
info@zebraproducts.co.uk

### Italy



Giancarlo Dossena  
Via Don Minzoni, 25  
I - 26838 Tavazzano (LO)  
Tel. +39 (0) 3 71 47 01 66  
Fax +39 (0) 3 71 47 01 74  
fraukericarda@gmail.com

### Canada



Can-Pro Horse Equipment  
13329 Steeles Ave. West  
Hornby, ON  
Canada - L0P 1E0  
Tel. 001 877 2 23 76 70  
Fax 001 877 2 23 75 71  
info@canpro-horseequipment.com

### Norway



Three Horses Norge AS  
Lindhjemveien 19  
N - 3280 Tjodalving  
Tel. +47 (0) 33 11 40 00  
Fax +47 (0) 33 11 40 01  
s-h@scan-horse.com

### Austria



Alexander Strübel  
Rathausgasse 2  
D - 73457 Essingen  
Tel. +49 (0) 173 522 22 15  
struebel@sprengrer.de

### Poland



Fenix Horse sp. z o.o.  
ul. Wysogotowska 85  
62-081 Przemierowo  
Tel. +48 (0) 61 65 24 75 0  
Fax +48 (0) 61 65 24 75 6  
fenix@fenix.net.pl

### Sweden



Three Horses AB  
Platensgatan 20  
S - 59135 Motala  
Tel. +46 (0) 14 19 15 00  
Fax +46 (0) 14 19 15 05  
s-h@scan-horse.com

### Switzerland



Keller Pferdesport GmbH  
Einsiedlerstraße 8  
CH - 8820 Wädenswil  
Tel. +41 (0) 44 786 36 28  
Fax +41 (0) 44 786 36 27  
Mobil +41 (0) 79 285 09 36  
info@keller-pferdesport.com

### Spain



Zaldi  
Sillas de Montar, S.A.  
Parcela 112, Apartado 502  
E - 37008 Salamanca  
Tel. +34 (0) 9 23 19 03 65  
Fax +34 (0) 9 23 19 03 77  
zaldi@zaldi.com

### USA



German Equestrian Manufacturers  
Lori Carter  
475 S. Commerce Street  
U.S.A. Hurricane, UT 84737  
Toll Free: 866 - Gem-Tack  
Tel. 001 (4 35) 2 51 94 10  
Fax 001 (4 35) 2 51 96 94  
GemTack@msn.com

The background of the advertisement is a dark, industrial scene. In the upper half, a ladle pours molten metal into a mold. In the lower half, a welder is working on a metal structure, with a bright blue and yellow flame from the welding torch illuminating the scene. The overall atmosphere is one of precision and industrial strength.

**HS SPRENGER**

**MADE FOR  
YOUR SUCCESS**



since 1872



**I. Scope of Application:**

- The following General Business Conditions will apply to all transactions with Herm. Sprenger GmbH (hereinafter known as "the supplier"), i.e. all contracts, deliveries and other services and shall be deemed to be incorporated into future business relationships even when reference has not especially been made to the same. The validity of the purchaser's General Terms of Business is discounted.
- Any deviations from these General Terms of Business will only become an integral part of the contract if such deviations constitute the subject matter of an express agreement in writing entered into between the purchaser and the supplier.

**II. Subject Matter of Contract/Prices:**

- Decisive for the contents and scope of deliveries and services is the written confirmation of order from the supplier. If no such confirmation has been issued then the quotation from the supplier is decisive. Should there be no quotation, then the supplier's current price list is decisive. Confirmation of order by data telecommunication, EDP-printout and electronically transferred order confirmations and quotations are to be considered as valid even without signature.
- Our quotations will be valid for 8 days, whereafter they lose their validity.
- Orders received via our agents and/or sales representatives together with subsidiary agreements, supplements, etc. require confirmation in the above mentioned form (written) to become effective.
- All the technical data contained in our catalogues and other sales documentation, lists and drawings as well as details of weights and measures have been drawn up with all due diligence; obvious mistakes are subject to subsequent correction.
- The price lists applicable at the time of entering into the contract constitute the basis for price calculations or alternatively the prices in the specific quotations. All prices are understood to be ex works and do not include the Value Added Tax applicable on the day of delivery or services performed and do not include any transport and packaging costs.
- For orders of low value, we reserve the right to charge a processing fee.

**III. Delivery Terms/Delayed Deliveries:**

- The observance of agreed periods for deliveries and performance of services or delivery dates is conditional on the timely receipt of all specifications and documents to be communicated by the purchaser as well as the compliance with the payment conditions agreed upon together with any other obligations through the purchaser. Should these prerequisites not be fulfilled punctually, then the delivery dates will be delayed commensurately.
- Transactions for delivery by a fixed date (§ 376 German Commercial Code) require explicit written confirmation.
- Should the non-compliance of delivery dates or service periods be caused by Force Majeure, e.g. mobilization, war, uprising, or any similar events, such as strike, lock-outs etc., then the dates or periods will be commensurately extended. The same is to apply for delayed deliveries of the supplier's own supplies.
- Should the supplier's delivery dates or service dates or alternatively the delivery periods or service periods on behalf of the supplier not be observed, then the purchaser is obliged to set the supplier a reasonable subsequent date for delivery in writing. Should the supplier culpably not deliver or alternatively perform services within this set subsequent delivery period, then the purchaser is entitled to withdraw from the contract.
- Inasmuch as the supplier is responsible for the non-observance of the accepted date, then the purchaser – provided he can substantiate that damages have thus arisen for him – can demand compensation for each complete week of delay of 0.5%, however, no more than a total of 5% of the price of the deliveries or services affected by the delay. This limitation of liability shall not be applicable if the supplier is to be blamed with handling with intent or with gross negligence or is compulsorily liable for damages arising from death or injury to body and health.
- On demand by the supplier, the purchaser is obliged to explain within a commensurate period whether he withdraws from the contract because of the delays in delivery or performance and/or will make claim for compensation instead of the deliveries demanded and/or insists on receiving the deliveries/performance.

**IV. Terms of Delivery:**

- The supplier is entitled to make partial deliveries on a reasonable scale. Variances in respect of the measurements, the weight, the technical configuration, the manufacture and the extent of the commodities to be supplied are permitted within a tolerance range of 15%.
- The purchaser additionally consents to any deviating modifications which serve technical improvement of the commodity or alternatively that will not bring about any technical deterioration.

**V. Passing of Risk/Delivery:**

- Dispatch is made on the order of the purchaser at his cost through a haulage contractor of our choice.
- The risk of accidental destruction and/or loss passes to the purchaser with the despatch or upon handing over to the person carrying out the transportation, respectively. Moreover all risk passes to the purchaser once he is in default of acceptance following receipt of notice of readiness for shipment from the supplier.

**VI. Terms of Payment:**

- The supplier's invoices are due for payment immediately and without any deduction. Payment is considered to have been made as soon as the sum has been made available to the supplier.
- The supplier reserves the right to demand payment in advance should he so desire.
- Should the purchaser fall into arrears, then the supplier can demand interest on arrears in the amount of 8% p.a. over the valid basic interest rate in accordance with § 247 German Civil Code. Any right to assert further claims for damages shall not be affected by this.
- The supplier is not obliged to accept drafts (Bills of Exchange). These will only be accepted in individual cases on account of performance by reason of special agreements. The discount and collection charges for the draft are to be borne by the issuer upon maturity and are payable immediately in cash.
- Regardless of any single instances of specially agreed payment conditions, demands to which the supplier is legally entitled become immediately due when circumstances arise in the person of the purchaser where any holding to the agreed payment conditions can no longer be deemed acceptable. This is the case if there are grounds to suspect a significant deterioration of the financial position of the purchaser, in particular upon suspension of payments, cheque and draft protests or default of payment, if it is apparent from this that the supplier's claim to the consideration is endangered as a result of the purchaser's lack of ability to pay. In such cases the supplier is furthermore entitled to demand contemporaneous payment with delivery or the surrender of additional securities. Above and beyond this the supplier is entitled to determine a reasonable term within which the purchaser, at the option of the supplier, is to simultaneously execute consideration or provide security in exchange for performance. The supplier may withdraw from the contract upon futile expiry of the said term.
- Within the scope of the warranty for defects the purchaser may only withhold payment after making a justifiable notice of defects to an extent that is in due proportion to the incurred defect. Any lien on goods on the part of the purchaser is otherwise excluded. The purchaser only has the right to offset claims with uncontested or legally enforceable claims.

**VII. Reservation of Title:**

- The commodities supplied (goods subject to reservation) remain the property of the supplier until all claims on the part of the supplier against the purchaser arising from the business relationship have been met. The purchaser is not permitted to pledge or transfer ownership by way of security for the duration of the reservation of title. In the event of any pledge, seizure or other disposition or intervention by third parties, the purchaser shall immediately notify the supplier of the same.
- The purchaser is entitled to dispose of the goods subject to reservation in the normal course of business provided he receives the agreed remuneration or a prohibition of assignment is not agreed upon. The purchaser herewith preventatively assigns to the supplier the claim arising from the sale. However, he remains duly authorised to the collection of the preventatively assigned claim, as long as such authorisation is not revoked. The authorisation can then be revoked when the purchaser culpably does not or no longer fulfil his contractual obligations. If a direct debit authorisation is revoked, the supplier is permitted to give notice of the occurred assignment. The purchaser must then immediately make available all the documents necessary for the notification of assignment and the collection.
- A sale in the ordinary course of business is not constituted if the goods subject to reservation are pledged or transferred by the purchaser by way of security to a third party, or made the object of factoring and/or sale-lease-back procedures, in violation of sub clause 2.
- In the event of goods subject to reservation being processed or treated, this shall be effected for and on behalf of the supplier as the manufacturer within the sense of §§ 950 et seq. German Civil Code. In this case the supplier is lawfully entitled to [joint] ownership of the articles emerging from the processing or treatment of the goods subject to reservation in the proportion of the goods subject to reservation to the value of the

new article at the time of the said processing or treatment. The supplier is likewise entitled to a proportional co-ownership in the new article whenever goods belonging to third parties are processed together with the goods subject to reservation. If the purchaser sells the article newly manufactured by him to another party, he herewith preventatively assigns the claim due to him arising from that sale to the amount of the value of the goods subject to reservation.

- The purchaser shall immediately notify the supplier if the goods subject to reservation are damaged or otherwise impaired. Any claims against third parties arising from the damage or impairment in favour of the purchaser are herewith preventatively assigned to the supplier.
- Insofar as the value of all security interests to which the supplier is entitled exceeds the amount of all claims covered by security by more than 20% the supplier shall if requested by the purchaser, release a corresponding portion of the security interests.
- Should the purchaser neglect any of his duties, in particular in the case of default of payment, the supplier is entitled to cancel the contract and to take back the goods subject to reservation. The purchaser is obliged to surrender the same. The taking back of the goods subject to reservation, or the enforcement of the reservation of title alone does not require the withdrawal on the part of the supplier and is not to be deemed as an implied declaration of cancellation of the contract unless the supplier explicitly declares that these acts are to be understood as a cancellation.

**VIII. Warranty:**

- The recipient is obliged to examine the commodities delivered immediately regarding their completeness, outer discernable damages and following normal business procedures carry out feasible checks in addition to making written report of any possible damages without delay.
- No warranty claims shall exist in the event of only immaterial deviation from the agreed condition and only insignificant impairment of the serviceability.
- Furthermore no warranty claims shall exist in the case of fair wear and tear, or by damage arising subsequent to the passing of risk as a result of incorrect or negligent handling, excessive treatment, unsuitable operating materials or that occur as a result of particular external influences that are not presupposed according to the contract
- In the event of a substantiated notice of defects, i.e. upon the occurrence of quality defects which, or the cause of which, already existed at the time of the passing of risk, the supplier is entitled, at his option, to provide subsequent improvement (removal of defects) or delivery (replacement).
- The warranty for expenses incurred by subsequent improvement is limited to the value of the defective commodities.
- If the supplier supplies a faultless item for the purpose of subsequent performance, the purchaser shall surrender the defective article. This is correspondingly applicable to defective components if these are replaced by faultless components within the scope of subsequent improvement.
- A warranty term of one year shall apply for claims for defects, insofar as the statutory provisions concerning the sale of consumer goods are not applicable (§§ 474 et seq. German Civil Code) in particular with regard to liability upon recourse (§§ 478 et seq. German Civil Code) in the absence of statutory requirements.
- The legal consequences of any violation of the commercial duty to examine goods and the obligation to give notice of defects (according to § 377 German Commercial Code) shall not be affected.
- Clause XI shall otherwise apply to any claims for damages. Claims are excluded that are more extensive or different from those in this sub-clause and clause XI raised on the part of the purchaser against the supplier and his vicarious agents due to a defect of quality.

**IX. Returning Commodities:**

- Any consignments of faultless goods returned require the prior written agreement of the supplier. For the acceptance of faultless goods the supplier will charge a lump-sum amount for handling to the amount of 30% of the value of the goods. Furthermore, the purchaser will bear all transport costs as well as the costs of packing, repacking and any possible repairs.

**X. Compensation/Liability:**

- Claims for compensation on the part of the purchaser are excluded, irrelevant of the legal grounds, in particular due to any breach of obligations arising from the contractual obligations and from tortious acts, unless there is compulsory liability in accordance with product liability laws, in cases of liability for intention or grossly negligent conduct, due to fatal or physical injury or health hazard, or due to the infringement of essential contractual obligations.
- Claims for compensation in respect of the violation of essential contractual obligations shall, however, be limited to predictable damages typical for the contract, unless a limitation is excluded for other reasons due to intentional or grossly negligent conduct, due to liability in accordance with product liability laws or due to fatal or physical injury or health hazard.
- In the event of impossibility of performance for which the supplier is responsible, claim for compensation by the purchaser is limited to 10 % of the value of that portion of the delivery which cannot be delivered due to impossibility of performance, as long as the supplier cannot be charged with intent or gross negligence and there is no compulsory liability due to fatal or physical injury or health hazard. The right of the purchaser to withdraw from the contract remains untouched.
- In the event that the purchaser's customer, or his customer, justifiably claims against him for subsequent performance, he shall give the supplier the opportunity to carry out such subsequent performance himself within a reasonable term before procuring other "compensatory" goods. The purchaser shall impose this obligation accordingly to his customer. In the event that the purchaser violates these obligations, the supplier reserves the right to reduce compensation to an amount he would have incurred by carrying out subsequent performance himself. This shall not affect § 444 German Civil Code.
- Compensation for expenses associated with such subsequent performance on the part of the purchaser in respect of his customer are furthermore excluded if the purchaser, contrary to his duty to limit damages, has not made use of his right to refuse this kind of subsequent performance, or both kinds of subsequent performance, because of the disproportion of costs and/or has not limited compensation to a reasonable amount.
- Claims on the part of the purchaser in respect of expenses necessary to effect subsequent performance, in particular transport, travelling, labour and material costs, are excluded if the expenses increase due to the fact that the object of supply has been subsequently transferred to a different place to the one given by the purchaser as recipient address, unless such a transfer corresponds with its designated use. This is applicable to recourse liability accordingly.
- The statutes of limitation binding on these claims are applicable to any claims for damages and compensation in conjunction with the defectiveness of the goods or performance (cf. VIII. 7.). Claims for compensation caused by liability in accordance with product liability laws, in cases of liability for intentional or grossly negligent conduct, due to fatal or physical injury or health hazard, or due to the infringement of essential contractual obligations are subject to the statutes of limitation.

**XI. Data Protection:**

- Personal data concerning the purchaser obtained directly or indirectly within the scope of the business relationship or becoming known through third parties will be stored by the supplier in an automatic file and processed in the course of business (reference to BDSG) [Federal Data Protection Act].
- The supplier will observe the relevant data protection regulations (in particular those of the BDSG) during his use of the personal data.
- The purchaser consents to the processing by the supplier of personal data becoming known concerning him indirectly or through third parties.
- The supplier may pass on to the supplier current information concerning the company and the products e.g. in the form of a newsletter concerning changes in the sales programme.

**XII. Miscellaneous:**

- The supplier reserves all property rights, copyrights and exploitation rights to quotations, drawings and other records (herein referred to as "documents") without limitation. The documents shall only be made accessible to third parties with the prior consent of the supplier and are to be returned immediately on request if the contract is not awarded to the supplier. Sentences 1 and 2 above apply to the purchaser's documents accordingly, although these may be made accessible to such other persons to whom the supplier has legitimately assigned the deliveries.
- The legal relations in conjunction with this contract are governed by German substantive law and exclude the United Nations Convention on Contracts for the International Sale of Goods (CISG).
- The sole legal venue for all disputes arising directly or indirectly from the contractual relationship shall be the registered office of the supplier.
- Should any provision in these Terms and Conditions or any provision in other agreements be or become ineffective, then this shall not affect the effectiveness of all the remaining provisions or agreements.

**QUALITIES AVAILABLE**

00	miscellaneous
01	steel nickel plated
02	steel chrome plated
04	steel brass plated
05	steel polished
06	steel galvanised
14	steel varnished
30	brass polished, I. quality
31	brass polished, I. quality nickel plated
32	brass polished, I. quality chrome plated
33	brass polished, II. quality
34	brass polished, II. quality nickel plated
35	brass polished, II. quality chrome plated
39	neverrust zinc plated
40	German Silver highly polished
43	German Silver mechanically polished
44	neverrust mechanically polished chrome plated
45	highly polished
48	aluminium mechanically polished
49	aluminium mechanically polished
50	neverrust brass plated
51	aluminium waterproof
55	HS-stainless steel
56	stainless steel
61	HS-stainless steel, anthracite
62	HS-stainless steel, bronze
71	rubber black
72	rubber white
74	rubber red
75	rubber brown
78	<b>SENSOGAN</b> with stainless steel rings / cheeks
79	<b>SENSOGAN</b> with Aurigan rings / cheeks
88	Aurigan with stainless steel rings / cheeks
89	Aurigan with Aurigan rings / cheeks
94	Copper Plus
*	 stocked in the US

**MEASURES**

mm	inch	mm	inch
1,0 mm	3/64	33,0 mm	1.19/64
1,5 mm	1/16	35,0 mm	1.3/8
2,0 mm	5/64	36,0 mm	1.27/64
2,5 mm	3/32	38,0 mm	1.1/2
3,0 mm	1/8	40,0 mm	1.5/8
4,0 mm	5/32	45,0 mm	1.3/4
5,0 mm	13/64	50,0 mm	1.31/32
6,0 mm	15/64	55,0 mm	2.5/32
7,0 mm	9/32	60,0 mm	2.23/64
8,0 mm	5/16	65,0 mm	2.9/16
9,0 mm	23/64	70,0 mm	2.3/4
10,0 mm	25/64	75,0 mm	2.61/64
11,0 mm	7/16	80,0 mm	3.5/32
12,0 mm	15/32	90,0 mm	3.35/64
13,0 mm	33/64	95,0 mm	3.47/64
14,0 mm	35/64	<b>cm</b>	<b>inch</b>
15,0 mm	5/8	10,0 cm	4.
16,0 mm	5/8	10,5 cm	4.1/8
17,0 mm	43/64	11,0 cm	4.1/4
18,0 mm	45/64	11,5 cm	4.1/2
19,0 mm	3/4	12,0 cm	4.3/4
20,0 mm	3/4	12,5 cm	5.
21,0 mm	53/64	13,0 cm	5.1/8
22,0 mm	55/64	13,5 cm	5.1/4
23,0 mm	29/32	14,0 cm	5.1/2
24,0 mm	15/16	14,5 cm	5.3/4
25,0 mm	1.	15,0 cm	6.
27,0 mm	1.1/16	15,5 cm	6.1/8
28,0 mm	1.7/64	16,0 cm	6.1/4
30,0 mm	1.1/4	16,5 cm	6.1/2
32,0 mm	1.17/64	17,0 cm	6.3/4

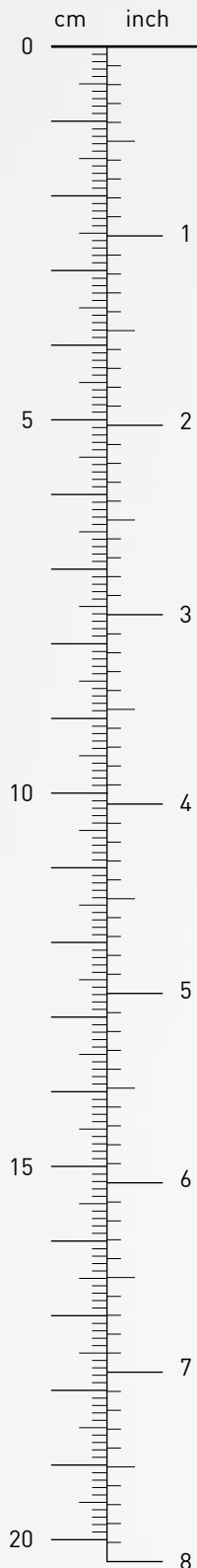

**HOW TO MEASURE A BIT**

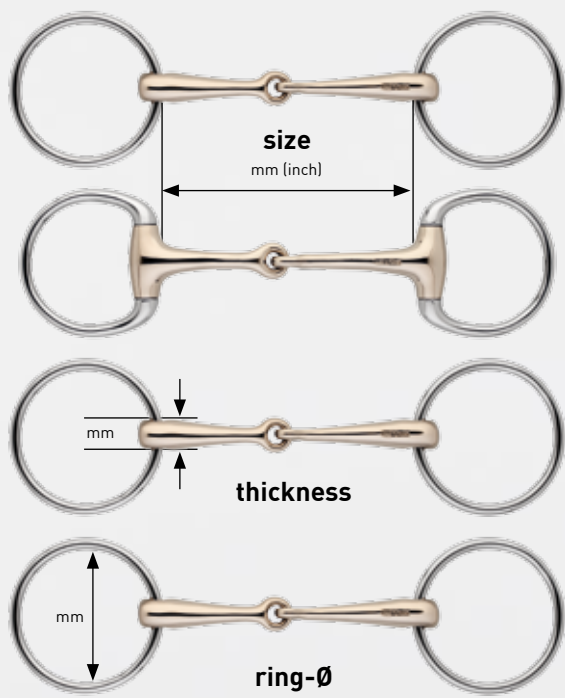

**LENGTH OF THE CHEEKS OF WEYMOUTH BITS AND PELHAMS**

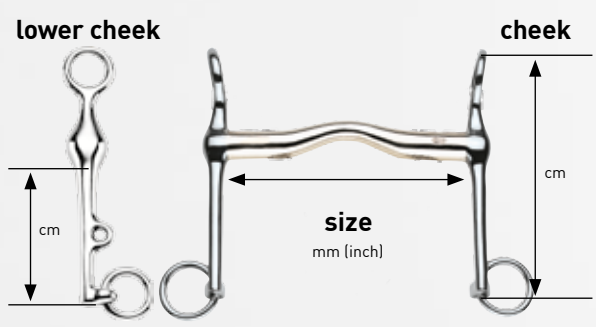

**ARTICLE NUMBERS**

Our product numbers consist of 10 digits. When ordering please choose the required quality and indicate the complete product number.

**40606** article + **130** size + **78** quality



HERM. SPRENGER GmbH Metallwarenfabrik  
Manufacturer of Equestrian Products

Postfach 24 53 • 58634 Iserlohn • Germany

Phone +49 (0) 23 71 95 59-0  
Facsimile +49 (0) 23 71 95 59-60  
herm.sprenger@sprenger.de  
www.sprenger.de